

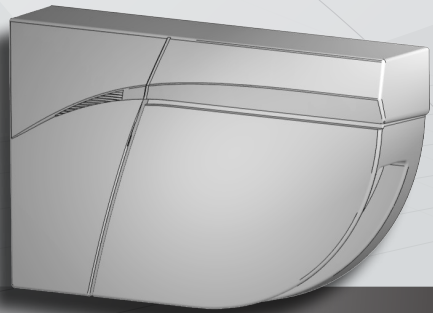

EN



# LZR<sup>®</sup>-FLATSCAN REV-LZ

SAFETY SENSOR FOR REVOLVING DOORS

User's Guide for software version 0203 and higher  
(refer to tracking label on product)



## INSTALLATION TIPS

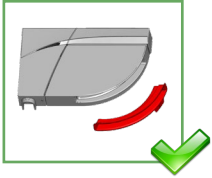

Remove the laser window protection before the teach-in and the commissioning of the sensor.

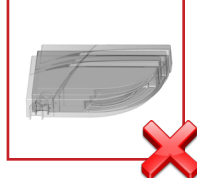

Avoid vibrations.



Do not cover the laser window.



Avoid moving objects and light sources in the detection field.



Avoid the presence of smoke and fog in the detection field.

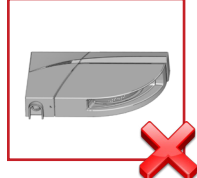

Avoid condensation.

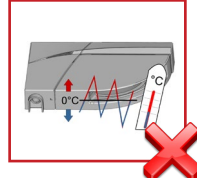

Avoid exposure to sudden and extreme temperature changes.

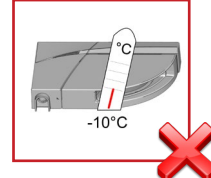

Keep the sensor permanently powered in environments where the temperature can descend below -10°C.

## MAINTENANCE TIPS

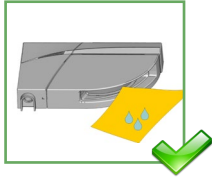

When needed, wipe the laser window only with a soft, clean and damp microfibre cloth.



Do not use dry or dirty towels or aggressive products to clean the laser window.

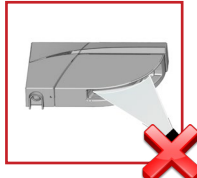

Avoid direct exposure to high pressure cleaning.

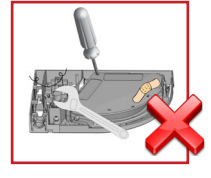

The warranty is invalid if unauthorized repairs are made or attempted by unauthorized personnel.

## SAFETY TIPS

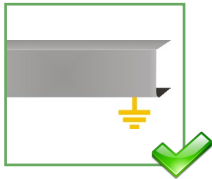

The door control unit and the door cover profile must be correctly earthed.

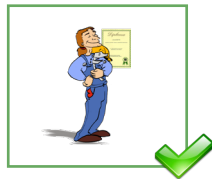

Only trained and qualified personnel may install and setup the sensor.

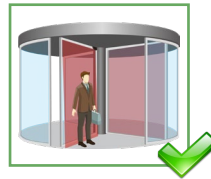

Always test the good functioning of the sensor and the door system in compliance with applicable national and international regulations and standards on door safety.

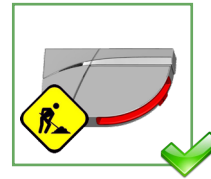

Do not remove the laser window protection if building works are still in progress on site.



- The device cannot be used for purposes other than its intended use. All other uses cannot be guaranteed by the manufacturer of the sensor.
- The manufacturer of the door system is responsible for carrying out a risk assessment and installing the sensor and the door system in compliance with applicable national and international regulations and standards on door safety.
- The manufacturer of the sensor cannot be held responsible for incorrect installations or inappropriate adjustments of the sensor.

## DESCRIPTION



The LZR®-FLATSCAN REV-LZ is a protective sensor for revolving doors based on laser technology. It detects the test body CA (acc. to EN 16005) in the area in front of the door wing. To do so, a module must be installed in the upper corner of each door leaf. Other protective equipment might be necessary in order to achieve compliance with 5.9.3 of EN 16005, depending on the analysis conducted by the door manufacturer.

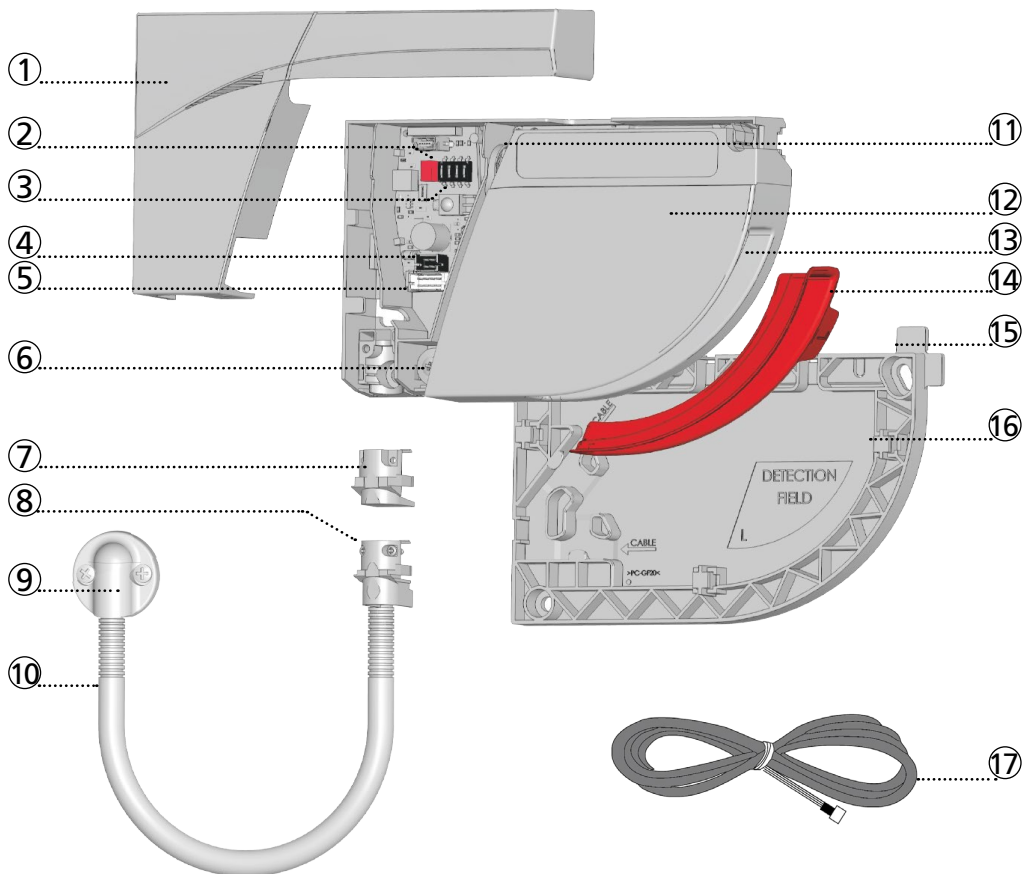

- |                               |                                  |                             |
|-------------------------------|----------------------------------|-----------------------------|
| 1. cover                      | 7. plug                          | 13. laser window            |
| 2. push button                | 8. clamp                         | 14. laser window protection |
| 3. DIP-switch                 | 9. cap and screws (flexible kit) | 15. positioning aids        |
| 4. spare connector (not used) | 10. flexible tube                | 16. mounting base           |
| 5. connector                  | 11. lock screw                   | 17. power cable             |
| 6. angle adjustment screw     | 12. laser head                   |                             |

## LED-SIGNALS

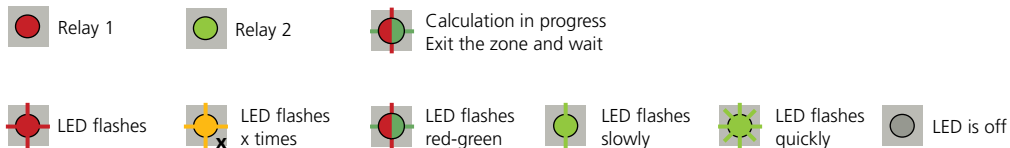

# 1 MOUNTING ON DOOR

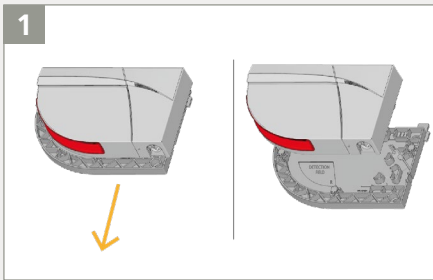
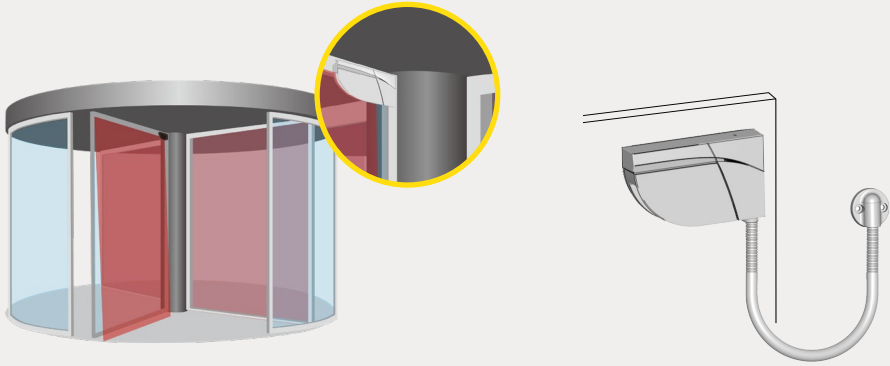

Slide the base off the sensor module.

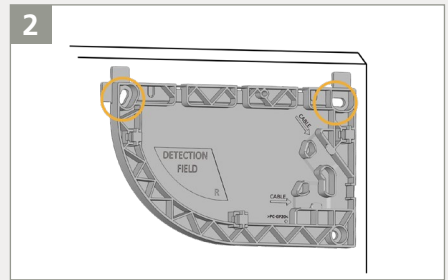

Take the base and put it on the door frame. The positioning aids help you to align the base correctly.



When mounting the base, make sure the sensor will not hinder the door movement.

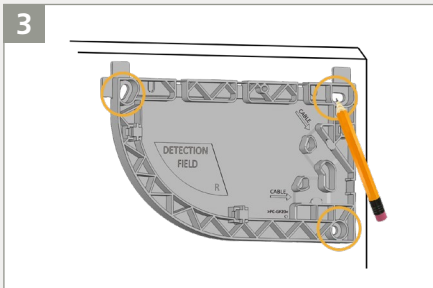

Using a pencil, mark the position of the holes to drill into the door frame. You can also use the inner surface of the base to fasten the screws.

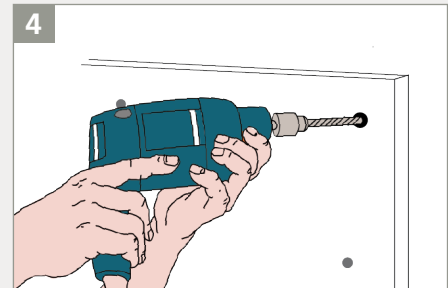

Remove the base and pre-drill the holes where marked.

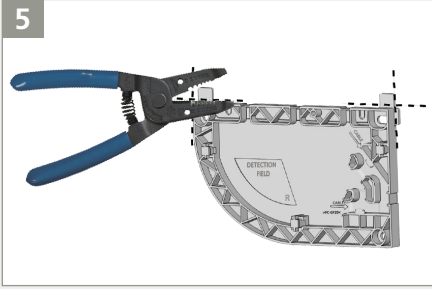

Using a wire cutter, remove the positioning aids from the base.

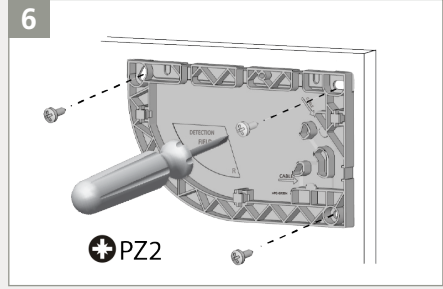

**⚠** Fasten the 3 screws using a Pozidrive screwdriver. The base needs to be fixed firmly!



*We provide two cabling modes (1a or 1b), please process following steps according to the site condition.*

## 1a HIDE CABLE INSIDE THE SENSOR

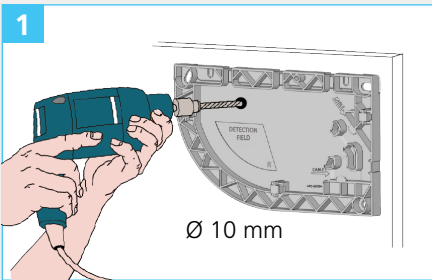

Drill through the base and the door using a 10 mm bit in order to pass the cable.  
Soften the edges using a sheet of sandpaper.

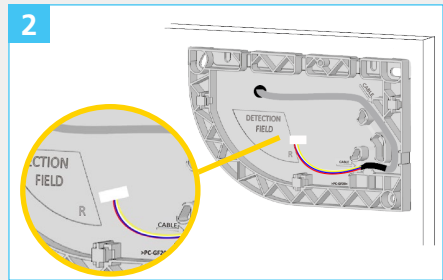

Take the cable and pass it through the hole. Position the cable in the notch of the base and make sure it is firmly fixed.

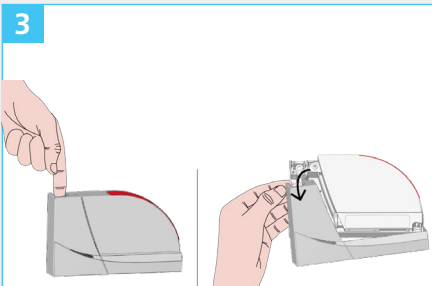

Take the sensor and remove the cover: put your finger in the hole and pull firmly towards you in one movement.

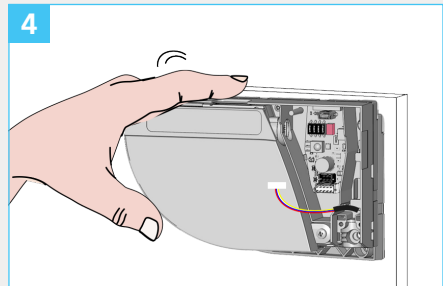

Pass the cable through the hole on the back of the sensor and fasten the sensor on the base by sliding it downwards.

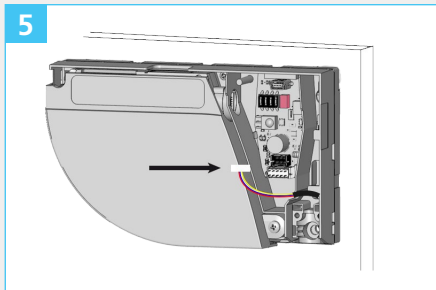

Connect the plug to the white connector.

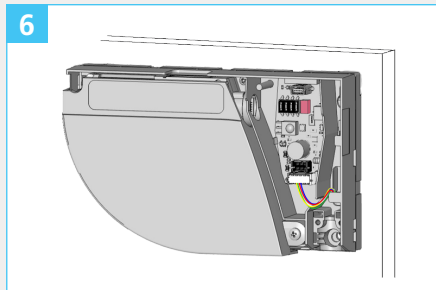

Make sure that all wires are safely tucked within the notch to avoid crushing them with the cover.

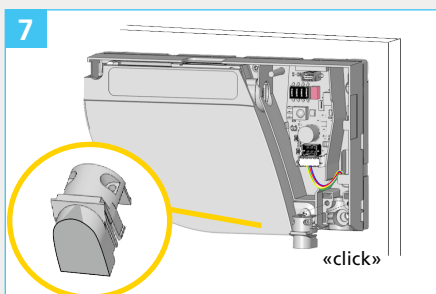

Close the sensor which will not be connected to the door controller using a plug.

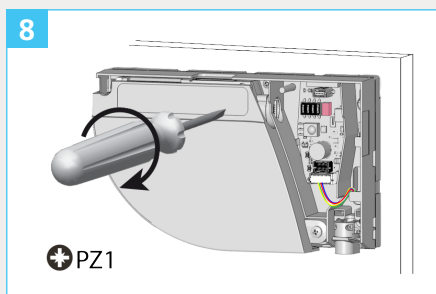

 Fasten the lock screw firmly.

## 1b EXTEND CABLE OUTSIDE THE SENSOR

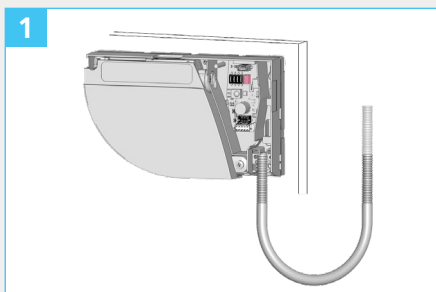

Take the flexible tube and determine how long it should be in order to reach the door controller.

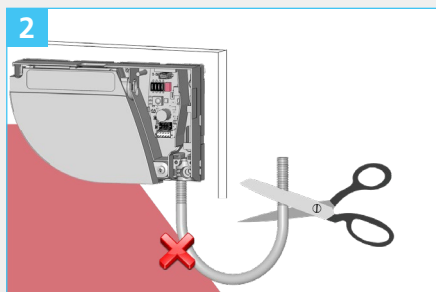

Cut the surplus to avoid undesired detections caused by the flexible tube.

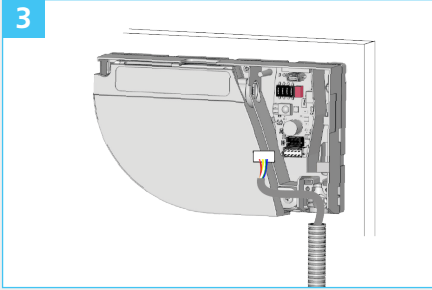

Pass the power cable through the flexible tube. Connect the plug to the white connector.

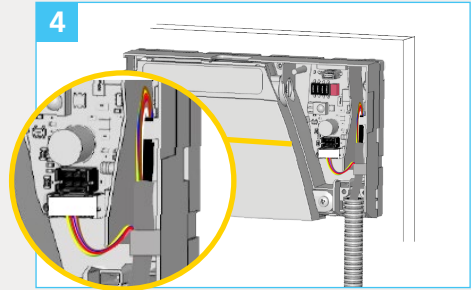

Make a loop with the wires of the power cable and pass them through the notch as indicated. Use the other part of the cable to block the wires.

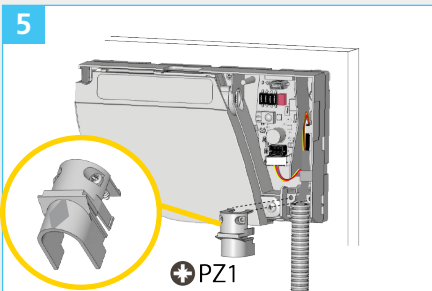

Take the clamp to fix the flexible tube to the sensor. Fasten the 2 screws firmly in order to avoid pulling out the cable.

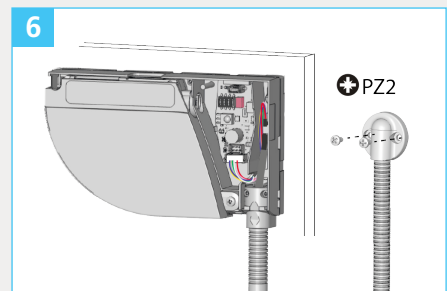

Tighten the other side of the flexible tube using the cable cap and pass through the rest of the power cable towards the door controller.

## 2 WIRING

12-24 V DC  GREEN +  
 BROWN - POWER SUPPLY

\* COM  YELLOW R1 OUTPUT 1  
 NC  WHITE

COM  PINK R2 OUTPUT 2  
 \* NC  GREY

 RED BLUE TEST

 YELLOW/BLACK WHITE/BLACK  (These wires are not used for the Flatscan LZ)

\* Output status when sensor is operational.



Cut the power cable to the right length, strip the 8 wires and connect all wires as indicated. The polarity of the power supply is important.

For compliance with EN 16005 and DIN 18650, the door controller test output must be connected and activated to test the sensor.



### 3 DIP-SWITCH 1

Make sure the setting of DIP 1 is correct.

TEACH-IN PROCESS

#### Standard Mode

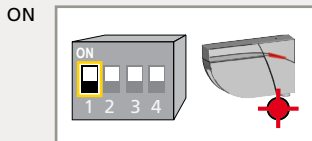

Output from R1, **red LED** flashes when there is a detection. **(Recommended Mode)**

#### Custom Mode

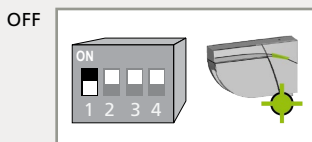

Output from R2, **green LED** flashes when there is a detection.

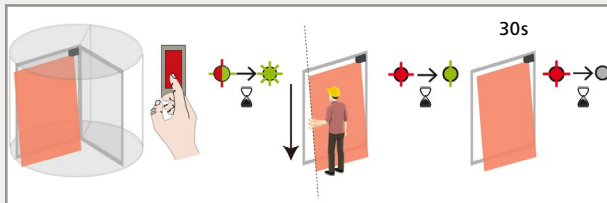

A **rectangle shape** can be traced in the detection area during the learning process of 30 seconds.

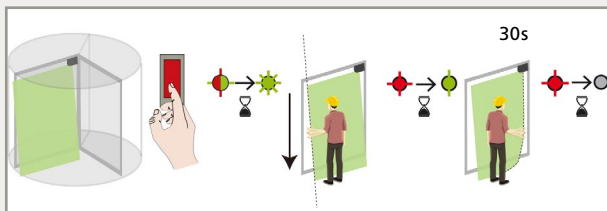

A **custom shape** can be traced in the detection area during the learning process of 30 seconds.



ORANGE



> 3 sec.



GREEN



OFF

After changing a DIP-switch, the orange LED flashes.

A LONG push on the push button confirms the settings.

### 4 TEACH-IN

Before launching a teach-in, make sure that:

- **glass surfaces near the door are covered**

- the door controller is set up first

- the detection field is free of snow buildups, heavy rain, snowfall, fog or other objects or people

- the laser window protection is removed.

1. To launch a teach-in, press the push button briefly. The LED starts to flash red-green quickly.
2. Wait until sensor flashes green quickly. Position yourself in front of the door and stretch out your arm in front of you. Make an up and down movement in front of the moving edge level in order to mark the limit of the detection zones. The LED flashes red while calculating the width of the door wings.
3.
  - **Standard Mode\***: The LED starts to flash red, then green slowly, next the red, no need to do anything during this process ( Make sure you're outside of the detection field ), wait until the LED is off, the teach-in is completed.
  - **Custom Mode**: The LED starts to flash red, then green slowly, then move your hand to define the detection field as your request, next LED flashes red. ( Make sure you're outside of the detection field ), wait until the LED is off, the teach-in is completed.

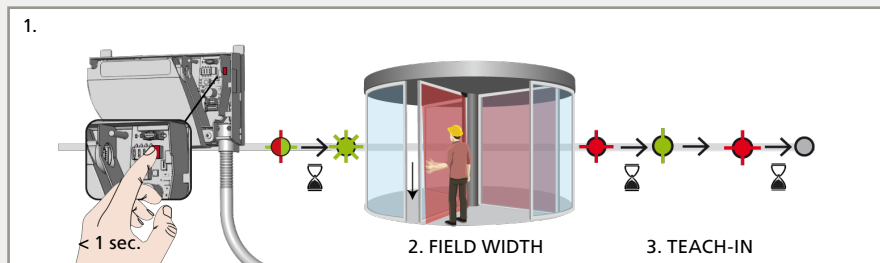

\* The default mode is **Standard Mode**.





## 5 TESTING AND ADJUSTING

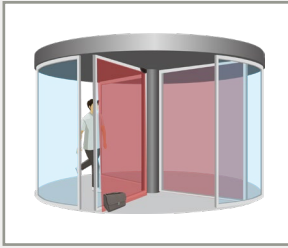

Check the correct positioning of the safety fields by placing an object in the detection field.

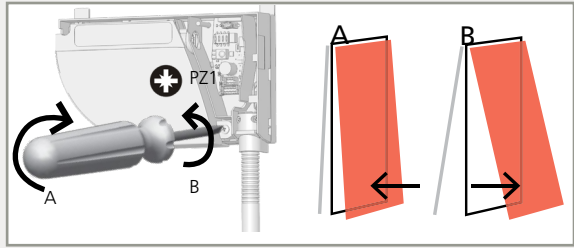

If necessary, adjust the tilt angle of the laser curtain by turning the tilt angle adjustment screw (from 2° to 10°).

**!** After changing the angle, the sensor position or the environment, always launch a teach-in and test the correct positioning of the detection fields.

## 6 FINAL STEPS

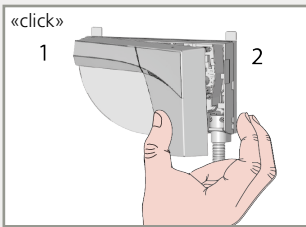

Close the cover starting on the narrow side (1). Do not hesitate to push.

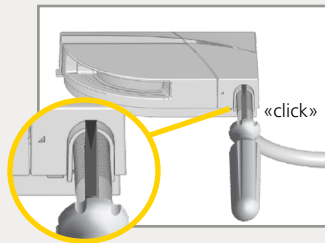

To open the sensor again, position a screwdriver in the notch and pull upwards until the cover comes loose.

## SERVICE MODE

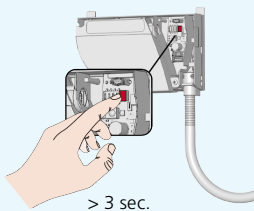

The service mode deactivates the safety detection during 15 minutes and can be useful during an installation, a mechanical teach-in of the door or maintenance work.

To enter the service mode, push on the button for at least 3 seconds. When the sensor is in service mode, the LED is off.  
To exit the service mode, push again for at least 3 seconds.

The service mode is deactivated automatically when launching a teach-in.



## DIP-SWITCH SETTINGS (OPTIONAL)

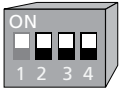

	ON	OFF	
<b>DIP 2 ENVIRONMENT</b>	standard	critical	Switch to CRITICAL when external disturbances are likely to cause unwanted detections (min. obj. size, immunity and uncovered zone are increased).
<b>DIP 3 BACKGROUND</b>	ON	OFF	Switch to OFF when there is no background (glass floor, footbridge...).
<b>DIP 4 OUTPUT CONFIGURATION</b>	NC	NO	Switch to NO when the door controller requires it.

After changing a DIP-switch, the orange LED flashes. A LONG push on the push button confirms the settings.

## REMOTE CONTROL SETTINGS (OPTIONAL)

**DIMENSIONS  
DOOR WING SAFETY**

0 0 0 0 0 1 - 4 0 0  
 no field                      001                      -                      400                      cm

0 0 0 0 0 1 - 4 0 0  
 no field                      001                      -                      400                      cm

A teach-in overwrites these values automatically.

**OUTPUT  
CONFIGURATION**

In order to change these settings by remote control, adjust DIP-switch 4 to ON

	1	2	3	4		NO	NC
R1	NO	NC	NC	NO	NO POWER		
R2	NC	NO	NC	NO	NO DETECTION		
					DETECTION		

NO = normally open    NC = normally closed

## IMMUNITY FILTER

In order to change these settings by remote control, adjust DIP-switch 2 to ON



Increase to filter out external disturbances.

The reaction time increases significantly between value 5 and 9.

## UNCOVERED ZONE

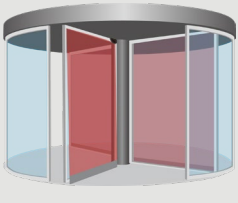

In order to change these settings by remote control, adjust DIP-switch 2 to ON

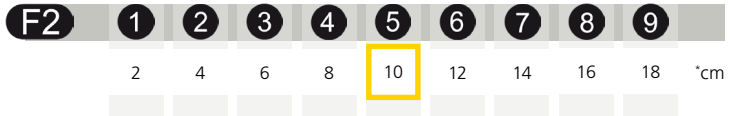

Increase in case of snow, dead leaves, etc.

\* Measured in specific conditions and dependant on application and installation.

## ANTIMASKING & BACKGROUND

In order to change these settings by remote control, adjust DIP-switch 3 to ON

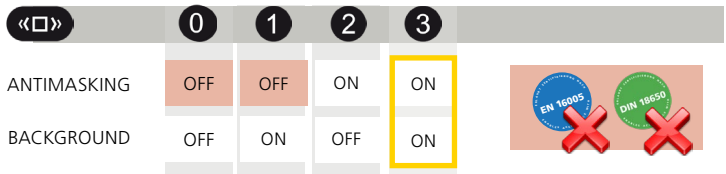

Antimasking: protective function which detects an unwanted object nearby the laser window masking the vision field.

Background: reference point in the detection field of the sensor.

If no background is present, switch to off.

## GENERAL

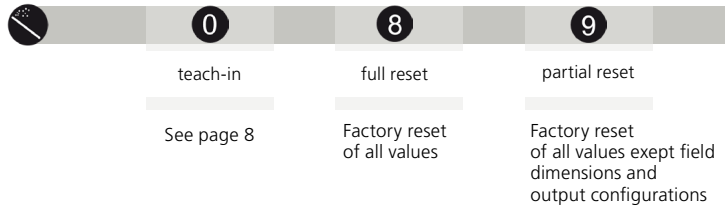

## HOW TO USE THE REMOTE CONTROL



After unlocking, the red LED flashes and the sensor can be adjusted by remote control.



If the red LED flashes quickly after unlocking, you need to enter an access code from 1 to 4 digits. If you do not know the access code, **cut and restore the power supply**. During 1 minute, you can access the sensor without introducing any access code.



To end an adjustment session, always lock the sensor.

It is recommended to use a different access code for each module in order to avoid changing settings on multiple modules at the same time.

## SAVING AN ACCESS CODE

The access code is recommended for sensors installed close to each other.



## DELETING AN ACCESS CODE



Enter the existing code

## ADJUSTING ONE OR MORE PARAMETERS

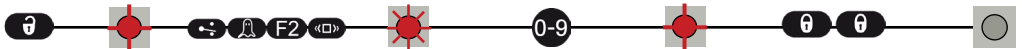

## CHECKING A VALUE



$x$  = number of flashes = value of the parameter

$2x$   $1x$   $3x$   $1x$   $5x$  = field width: 2.35 m

## RESTORING TO FACTORY VALUES

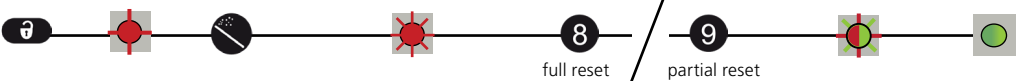



full reset

partial reset

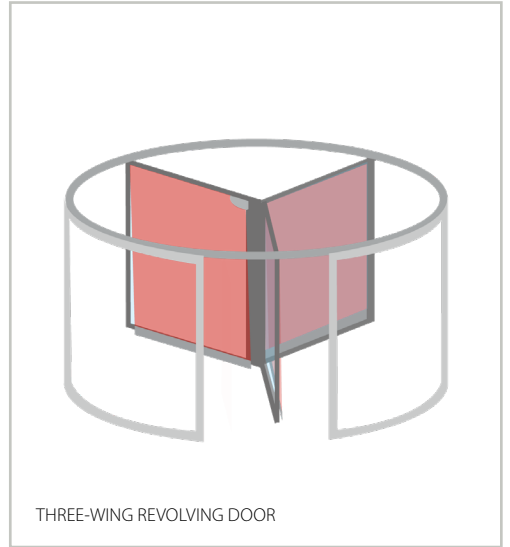
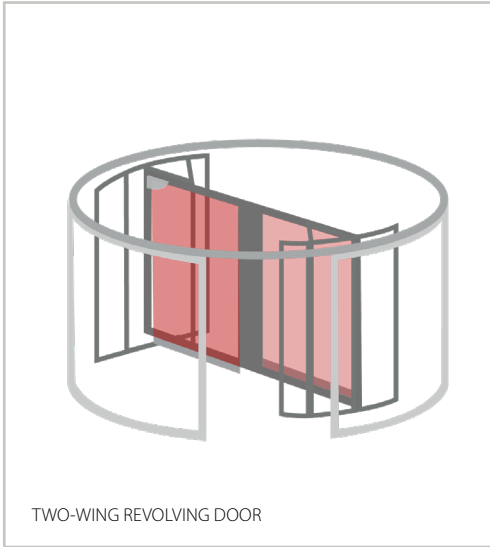
## DETECTION FIELDS



 DOOR WING SAFETY  
Typ. object size: 10 cm at 4 m

 UNCOVERED ZONE  
Adjustable by remote control  
Factory value: 10 cm

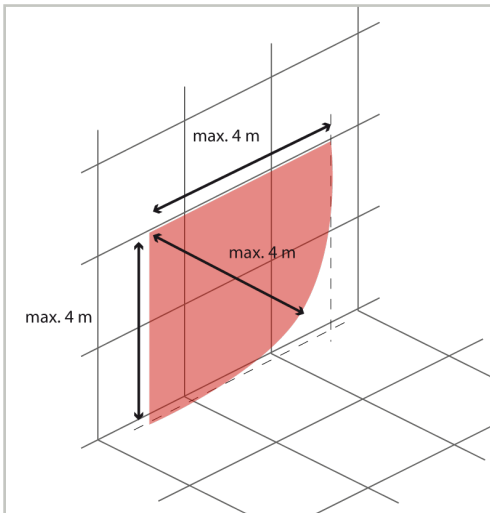

## TROUBLESHOOTING



In case of unwanted reactions of the door, verify whether the problem is caused by the sensor, or the door controller. To do so, activate the service mode (no safety) and launch a door cycle. If the door cycle is completed successfully, check the sensor. If not, verify the door controller, the wiring or other sensor.

 	The RED or GREEN LED is ON sporadically or permanently and the door does not react as expected.	Bad teach-in	Launch a new teach-in.
		Unwanted detections (due to environment or external conditions)	1 Make sure the flexible cable does not cause detections.
			2 Verify if the laser window is dirty and clean it with compressed air. Then wipe it carefully with a damp and clean microfibre cloth if necessary. (attention: the surface of the laser window is delicate)
			3 Launch a new teach-in.
4 Switch DIP 2 to off (critical environment).			
	The sensor does not react at power-on.	Inverted power supply	Check wiring (green +, brown -).
		Faulty cable	Replace cable
		Faulty sensor	Replace sensor
	The sensor does not react when powered.	Test error	Check voltage between red and blue wires.
		The service mode is activated	Press the push button during at least 3 seconds to exit the service mode.
	It is not possible to adjust a setting by remote control.	Wrong DIP-switch position.	Adjust the required DIP-switches to ON.
	The remote control does not react.	The sensor is protected by a password.	Enter the right password. If you forgot the code, cut and restore the power supply to access the sensor without entering a password during 1 minute.

	The ORANGE LED is on permanently.	The sensor encounters a memory problem.		Send the sensor back for a technical check-up.
	The ORANGE LED flashes quickly.	DIP-switch setting awaiting confirmation.		Confirm the DIP-switch setting: long push on the push button.
	The ORANGE LED flashes 1 x every 3 seconds.	The sensor signals an internal fault.		Cut and restore power supply. LED flashes again, replace sensor.
	The ORANGE LED flashes 2 x every 3 seconds.	Power supply is out of limit.	1	Check power supply (voltage, capacity).
			2	Reduce the cable length or change cable.
		Internal temperature is too high.		Protect the sensor from any heat source (sun, hot air...)
	The ORANGE LED flashes 3 x every 3 seconds.	Communication error between modules.	1	Check wiring between interface card and laser head.
	The ORANGE LED flashes 4 x every 3 seconds.	The sensor does not see its background.  Something close to the sensor is masking part of the detection field.		Switch DIP 3 to off (deactivates background).
			1	Make sure the laser window is not scratched. If it is, replace sensor.
			2	Remove all masking elements (insects, spider web, flexible tube, window protection).
			3	Verify if the laser window is dirty and clean it with compressed air. Then wipe it carefully with a damp and clean microfibre cloth if necessary (attention: the surface of the laser window is delicate)
4	Switch antimasking setting to off (attention: no conformity to DIN 18650 or EN 16005).			
	The ORANGE LED flashes 5 x every 3 seconds.	Teach-in error.	1	Check whether all teach-in requirements are fulfilled (see page 8) and launch a new teach-in.
			2	Adjust the tilt angle of the laser curtain and launch a new teach-in.
			3	Adjust the field dimensions by remote control.

## TECHNICAL SPECIFICATIONS

<b>Technology</b>	LASER scanner, time-of-flight measurement
<b>Detection mode</b>	Presence
<b>Max. detection range</b>	4 m (diagonal) with reflectivity of 2% (i.e.: at W = 1.5m -> max. H = 3.7 m)
<b>Opening angle</b>	90°
<b>Angular resolution</b>	1.3°
<b>Typ. min. object size</b>	10 cm @ 4m (in proportion to object distance, DIP 2 = ON)
<b>Testbody</b>	700 mm x 300 mm x 200 mm (testbody CA according to EN 16005 & DIN 18650-1)
<b>Emission characteristics</b>	IR LASER: wavelength 905 nm; output power < 0.1 mW; CLASS 1 (IEC/EN 60825)
<b>Supply voltage</b>	12 - 24 V DC $\pm$ 15 % (The Equipment must be powered by an approved Class II SELV limited power source. This requirement consists of the need for double insulation between primary voltages and the Equipment supply)
<b>Power consumption</b>	$\leq$ 2 W
<b>Response time</b>	50 ms
<b>Output</b> Max. switching voltage Max. switching current	2 electronic relays (galvanic isolation - polarity free) 42V AC/DC 100 mA
<b>LED-signals</b>	1 bi-coloured LED: detection/output status
<b>Dimensions</b>	142 mm (L) x 85 mm (H) x 33 mm (D) (mounting base + 7 mm)
<b>Material - Colour</b>	PC/ASA - Black - Aluminum - White
<b>Tilt angles</b>	+2° to +10° (without mounting base)
<b>Protection degree</b>	IP54 (IEC/EN 60529)
<b>Temperature range</b>	-30°C to +60°C if powered
<b>Humidity</b>	0-95 % non-condensing
<b>Vibrations</b>	< 2 G
<b>Compliance</b>	EN 16005 (test body CA) DIN 18650-1 (test body CA) EN 12978 EN ISO 13849-1 PL "d" / CAT2 IEC/EN 60825-1 IEC/EN 61508 SIL2

*Specifications are subject to change without prior notice. All values are measured in specific conditions.*

BEA SA | LIEGE Science Park | ALLÉE DES NOISETIERS 5 - 4031 ANGLEUR (BELGIUM) | T +32 4 361 65 65 | F +32 4 361 28 58 | E INFO@BEA.BE | www.beasensors.com



BEA hereby declares that the equipment type LZR®-FLATSCAN REV LZ is in compliance with European Directives 2006/42/EC (Machinery), 2011/65/EU (RoHS) and 2014/30/EU (EMC).

Notified Body for EC inspection: 0044 - TÜV NORD CERT GmbH, Langemarckstr. 20, D-45141 Essen.  
EC-type examination certificate number: 44 205 13089633 Estelle Graas, Angleur, July 2019

The complete declaration of conformity is available on our website.



This product should be disposed of separately from unsorted municipal waste.

