

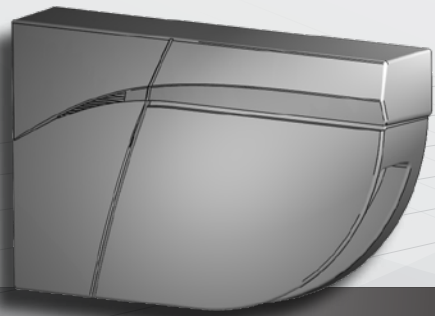

EN



LZR[®]-FLATSCAN SW CAN

SAFETY SENSOR
FOR AUTOMATIC SWING DOORS



User's Guide for software version 0100 and higher
Refer to tracking label on product

INSTALLATION TIPS

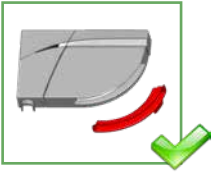

Remove the laser window protection before the teach-in and the commissioning of the sensor.

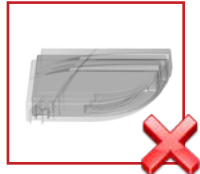

Avoid vibrations.

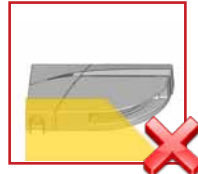

Do not cover the laser window.



Avoid moving objects and light sources in the detection field.



Avoid the presence of smoke and fog in the detection field.



Avoid condensation.

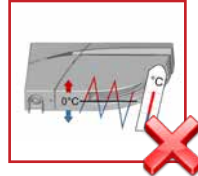

Avoid exposure to sudden and extreme temperature changes.

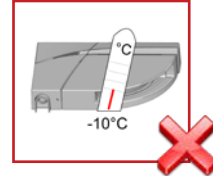

Keep the sensor permanently powered in environments where the temperature can descend below -10°C.

MAINTENANCE TIPS



Clean the laser window with compressed air. If needed, wipe only with a soft, clean and damp microfiber cloth.



Do not use dry or dirty towels or aggressive products to clean the laser window.



Avoid direct exposure to high pressure cleaning.

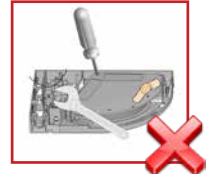

The warranty is invalid if unauthorized repairs are made or attempted by unauthorized personnel.

SAFETY TIPS

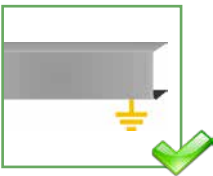

The door control unit and the door cover profile must be correctly earthed.



Only trained and qualified personnel may install and setup the sensor.



Always test the good functioning of the installation before leaving the premises.



Do not remove the laser window protection when building works are still in progress on site.

- ⚠ The sensor cannot be used for purposes other than its intended use.
- The manufacturer of the door system incorporating the sensor is responsible for compliance of the system to applicable national and international regulations and safety standards.
- The installer must read, understand and follow the instructions given in this manual. Improper installation can result in improper sensor operation.
- The manufacturer of the sensor cannot be held responsible for injury or damage resulting from incorrect use, installation or inappropriate adjustment of the sensor.

DESCRIPTION



The LZR-FLATSCAN SW CAN is a safety sensor for automatic swing doors based on laser technology. It secures the moving door wing as well as the hinge area. To do so, a module must be installed in the upper corner of the door wing on both sides of the door.

The LZR-FLATSCAN SW CAN requires the implementation of a dedicated fieldbus protocol for communication with the door controller. The sensor and the door controller must be compatible.

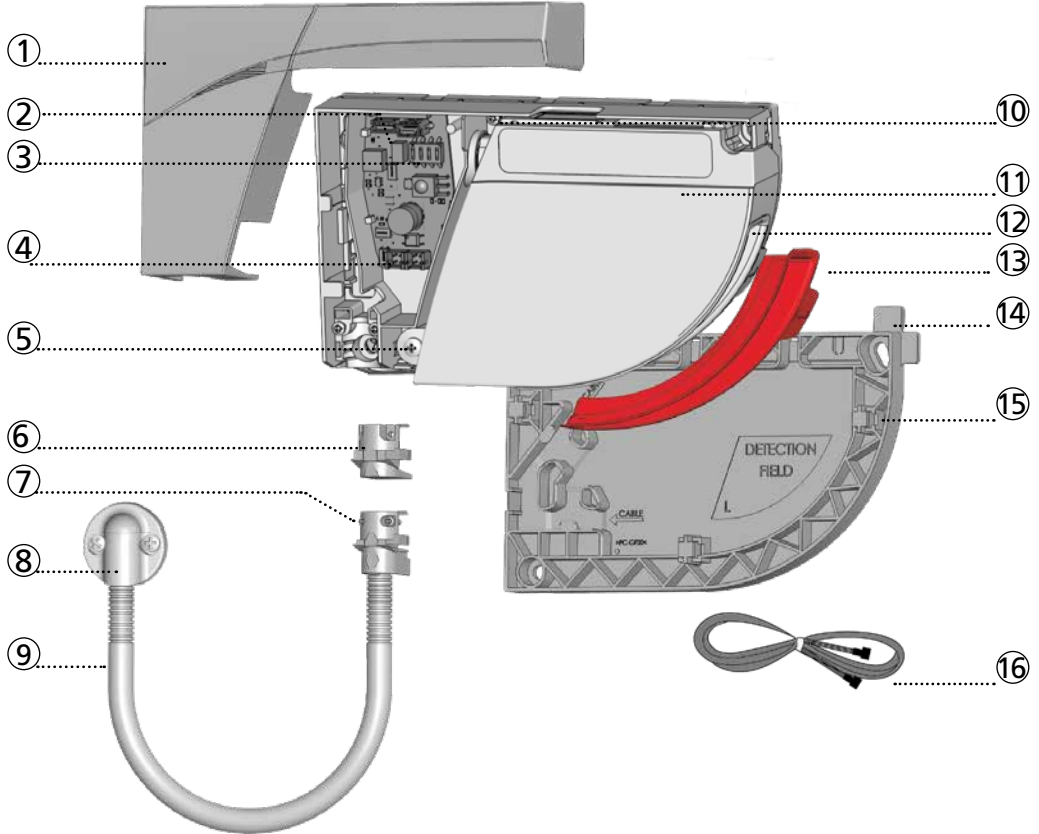

- | | | |
|---------------------------|----------------------------------|-----------------------------|
| 1. cover | 7. clamp | 13. laser window protection |
| 2. push button | 8. cap and screws (flexible kit) | 14. positioning aids |
| 3. DIP-switch | 9. flexible tube | 15. mounting base |
| 4. CAN connectors | 10. lock screw | 16. CAN cable |
| 5. angle adjustment screw | 11. laser head | |
| 6. plug | 12. laser window | |

LED-SIGNALS

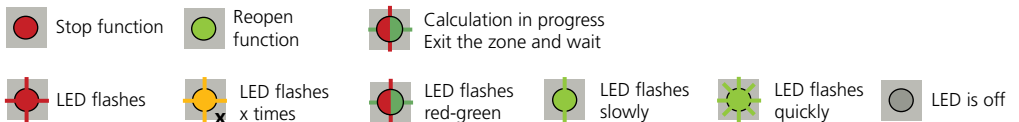

1 MOUNTING ON DOOR

 For optimum safety, install 1 module on each door wing side and interconnect them with a CAN cable.

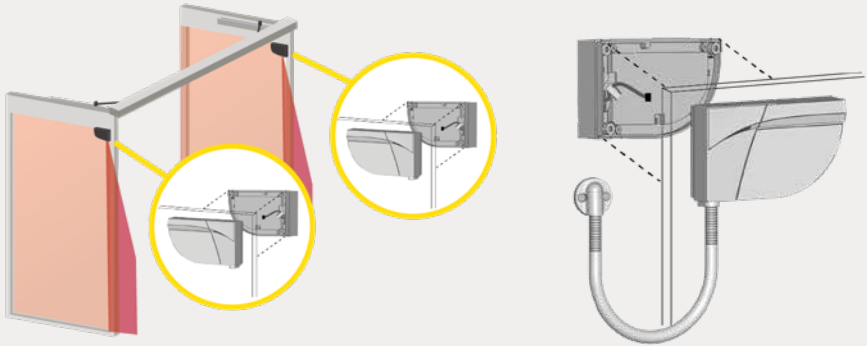

 Keep a minimum distance of 15 cm between the FLATSCAN and radar sensors or use the LZR®-FLATSCAN Protective cover to avoid unwanted reactions of the door.

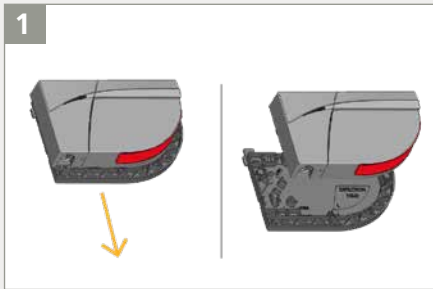

Slide the base off the sensor module.

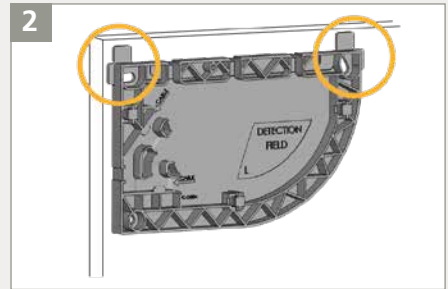

Take the base and put it on the door frame. The positioning aids help you to align the base correctly.

 When mounting the base, make sure the sensor will not hinder the door movement. If the sensor isn't correctly positioned, it could be crushed during the opening of the door.

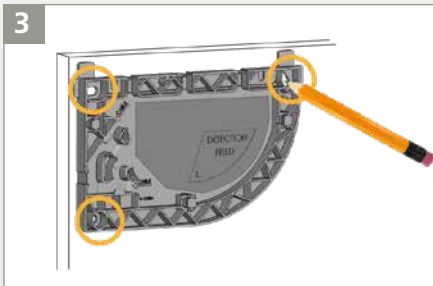

Using a pencil, mark the position of the holes into the door frame. You can also use the inner surface of the base to fasten the screws.

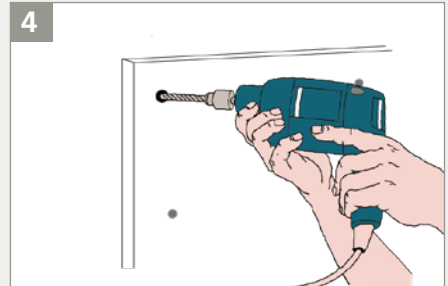

Remove the base and pre-drill the holes where marked.

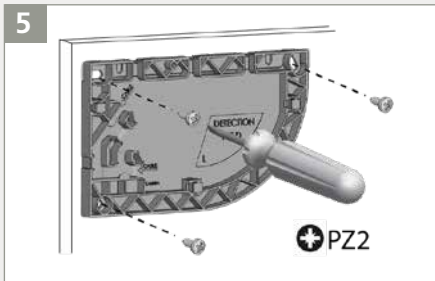

! Using a wire cutter, remove the positioning aids from the base. Fasten the 3 screws using a Pozidrive screwdriver. **The base needs to be firmly and securely fixed!**

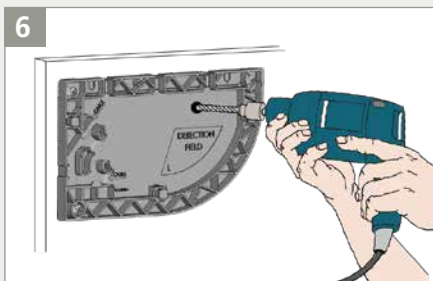

Drill through the 2 bases and the door using a 10 mm bit in order to pass the CAN cable. Soften the edges using a sheet of sandpaper.

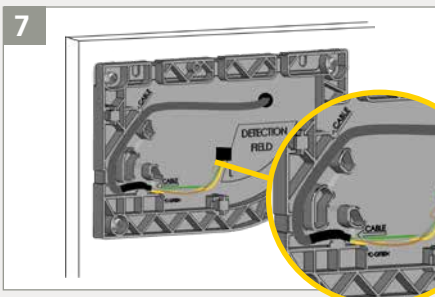

Take the CAN cable and pass it through the hole. Position the cable in the notch of the base and make sure it is firmly fixed.

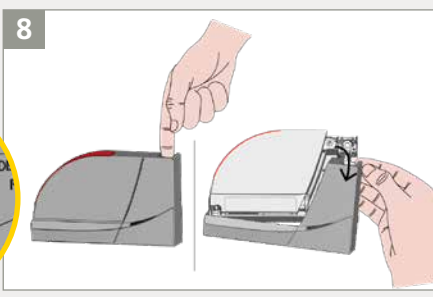

Take the sensor and remove the cover: put your finger in the hole and pull firmly towards you in one movement.

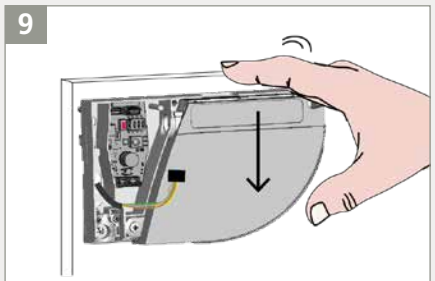

Pass the cable through the hole on the back of the sensor and fasten the sensor on the base by sliding it downwards.

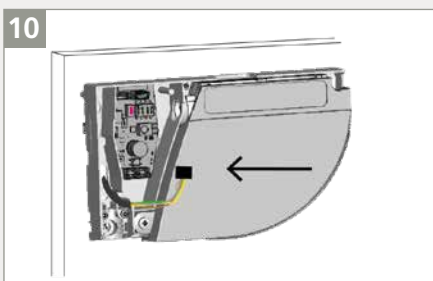

Connect the black plug to one of the black connectors. Make sure that all wires are safely tucked within the notch to avoid crushing them with the cover.

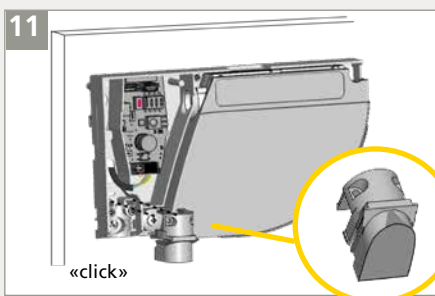

Close the sensor which will not be connected to the door controller using a plug.

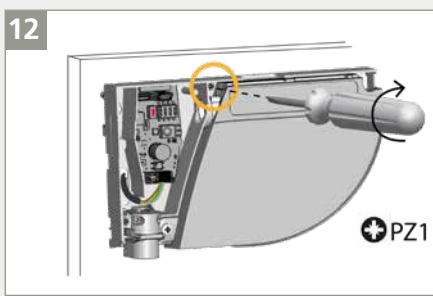

! Fasten the lock screw firmly.

2 WIRING TO DOOR CONTROLLER

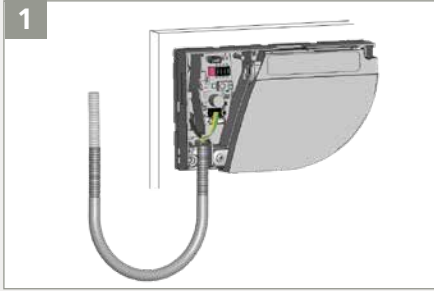

1 Take the flexible tube and determine how long it should be in order to reach the door controller.

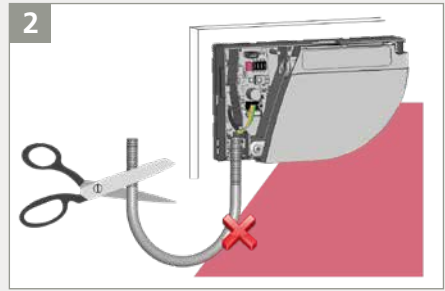

2 Cut the surplus to avoid undesired detections caused by the flexible tube.

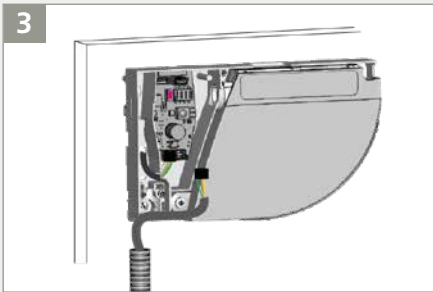

3 Pass the CAN cable through the flexible tube. Connect the plug to the second black connector.

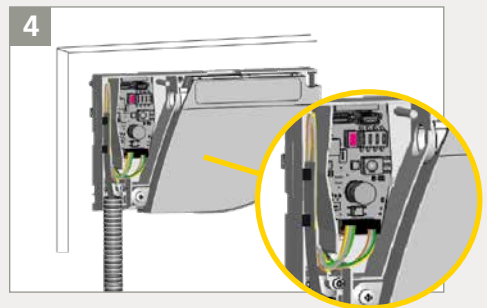

4 Make a loop with the wires of the CAN cable and pass them through the notch as indicated. Use the other part of the cable to block the wires.

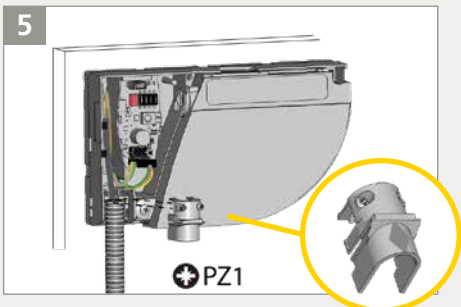

5 Take the clamp to fix the flexible tube to the sensor. Fasten the 2 screws firmly in order to avoid pulling out the cable.

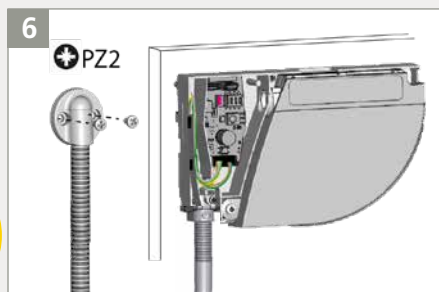

6 Tighten the other side of the flexible tube using the cable cap and pass through the rest of the CAN cable towards the door controller.

3 DIP-SWITCH 1

DIP SWITCH 1 : LEAF SIDE

Make sure the setting of DIP 1 is correct on all modules according to the door side.

ON



Opening side of the door = SECONDARY module

OFF



Closing side of the door = MAIN module



DIP SWITCH 2 - 3 : LEAF

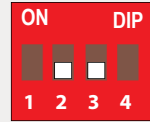

Leaf 1



Leaf 2



Leaf 3

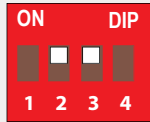

Leaf 4

   After changing a DIP-switch, the orange LED flashes quickly. Cut and restore power supply to confirm the setting.

EXAMPLE :

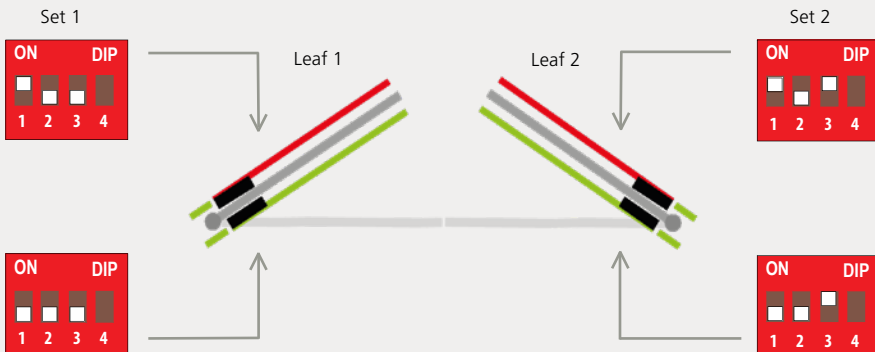

 Both sensors placed on the same door leaf must have DIP 2 and 3 on the same position !

DIP SWITCH 4 : POSITION IN CHAIN

On the last sensor of the chain, adjust DIP-switch 4 to on.

The white LED next to the DIP-switch will be on permanently.

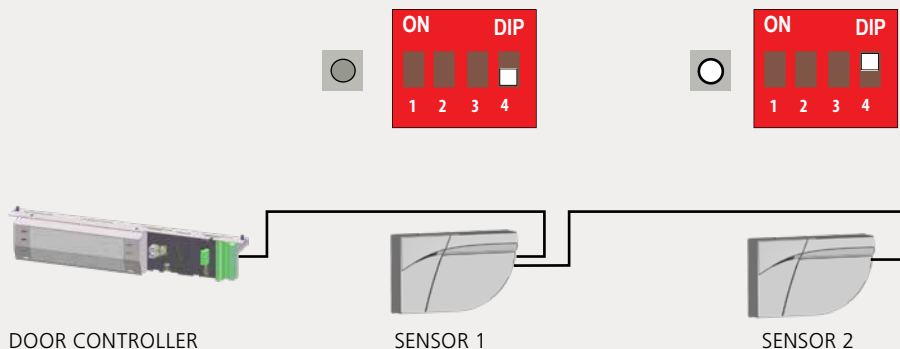

4 TEACH-IN



Before launching a teach-in, make sure that:

- **glass surfaces near the door are covered**
- the door controller is set up first
- the door is closed (use the service mode if needed, see page 9)
- the CAN cables are all correctly connected between the modules
- the door controller is reacting to the output signals
- the detection field is free of snow buildups, heavy rain, snowfall, fog or other objects or people
- the laser window protection is removed.

1. To launch a teach-in, press the push button of the MAIN* module briefly. The LED starts to flash red-green quickly. When installing the sensor on a double swing door, repeat this on the other MAIN module.
2. Wait until all MAIN modules flash green. Position yourself in front of the door and stretch out your arm in front of you. Make an up and down movement at closing edge level in order to mark the limit of the detection zones. The LED flashes red while calculating the width of the door wing.
3. Wait until all MAIN modules flash green again. The Flatscan SW CAN will open the door to learn the environment. If the door doesn't open you can activate a door opening. Make sure you are way outside of the detection field. During the closing of the door, the sensor flashes red.
4. Once the door is completely closed again and the LED is off, the teach-in is completed.

* A teach-in on the MAIN module configures both the MAIN and the SECONDARY modules. A teach-in on the SECONDARY module only configures the SECONDARY module. In case the MAIN and SECONDARY modules are not aligned (same height or same distance from the hinge), first launch a teach-in on the MAIN and then on the SECONDARY module.

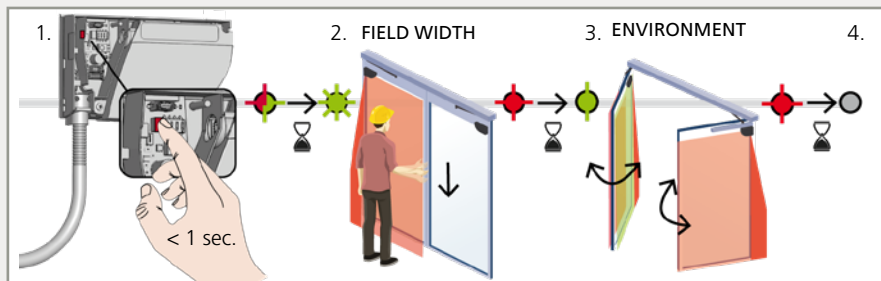

Launch a new teach-in each time the sensor tilt angle is changed or new objects are added to/changed in the detection zone.

5 TESTING AND ADJUSTING



Check the correct positioning of the safety fields by placing an object in the detection field.

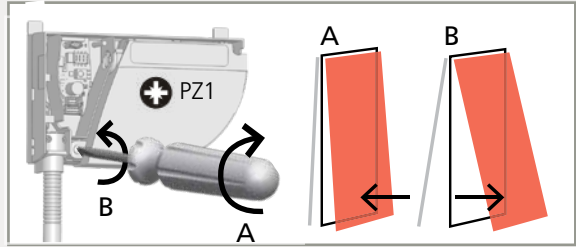

If necessary, adjust the tilt angle of the laser curtain by turning the tilt angle adjustment screw (from 2° to 10°).

! After changing the angle, the sensor position or the environment, always launch a teach-in and test the correct positioning of the detection fields.

6 FINAL STEPS

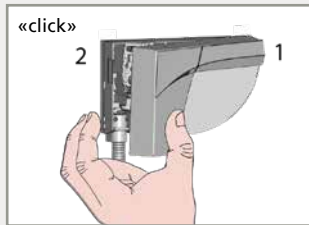

Close the cover starting on the narrow side (1). Do not hesitate to push.

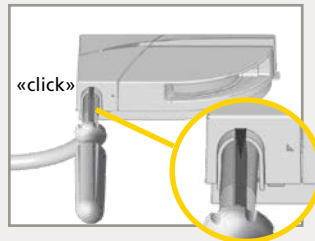

To open the sensor again, position a screwdriver in the notch and pull upwards until the cover comes loose.

SERVICE MODE

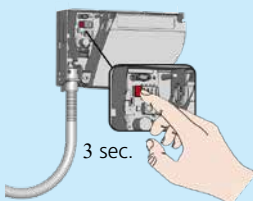

The service mode deactivates the safety detection during 15 minutes and can be useful during an installation, a mechanical teach-in of the door or maintenance work.

To enter the service mode, push on the button for 3 seconds.
When the sensor is in service mode, the LED is off.
To exit the service mode, push again for 3 seconds.

The service mode is deactivated automatically when launching a teach-in.



WIRING INFORMATION

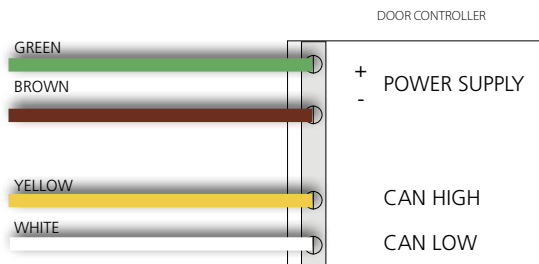

REMOTE CONTROL SETTINGS (OPTIONAL)

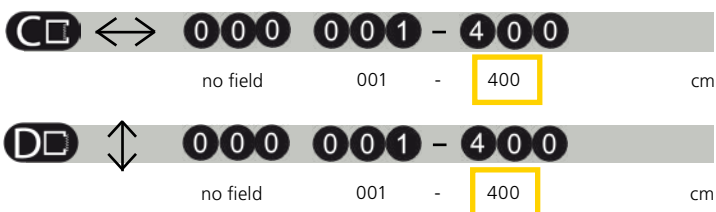

A teach-in overwrites these values automatically.

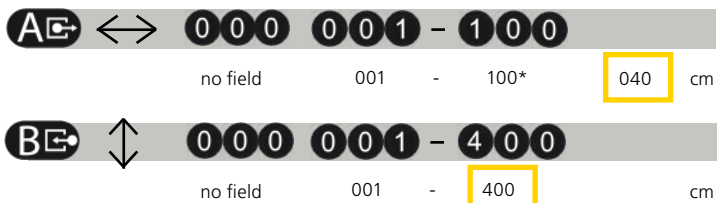

* The actual dimensions depend on the mounting height (100 cm at 4 m).

A teach-in overwrites these values automatically.



F2	1	2	3	4	5	6	7	8	9	
	2	4	6	8	10	12	14	16	18	cm*

Increase in case of snow, dead leaves, etc.
 * measured in specific conditions and dependant on application and installation.

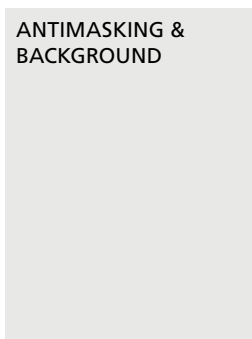

	«□»	0	1	2	3	
ANTIMASKING		OFF	OFF	ON	ON	
BACKGROUND		OFF	ON	OFF	ON	

Antimasking: protective function which detects an unwanted object nearby the laser window masking the vision field.
 Background: reference point in the detection field of the sensor.
 If no background is present, switch to off.

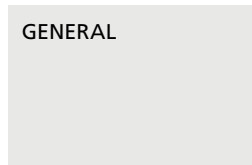

		0		8		9
		teach-in		full reset		partial reset
		See page 8		Factory reset of all values		Factory reset of all values except field dimensions

CAN SPECIFIC PRESETTING

ENVIRONMENT	standard	critical*
--------------------	----------	-----------

Switch to CRITICAL when external disturbances are likely to cause unwanted detections (min. obj size, immunity and uncovered zone are increased).

* Make a risk analysis to check if the environment requires an additional mechanical protection in the hinge area.

FACTORY VALUE

HOW TO USE THE REMOTE CONTROL



After unlocking, the red LED flashes and the sensor can be adjusted by remote control.



If the red LED flashes quickly after unlocking, you need to enter an access code from 1 to 4 digits. If you do not know the access code, **cut and restore the power supply**. During 1 minute, you can access the sensor without introducing any access code.



To end an adjustment session, always lock the sensor.



It is recommended to use a different access code for each module in order to avoid changing settings on both modules at the same time.

SAVING AN ACCESS CODE

The access code is recommended for sensors installed close to each other.



DELETING AN ACCESS CODE



Enter the existing code

ADJUSTING ONE OR MORE PARAMETERS

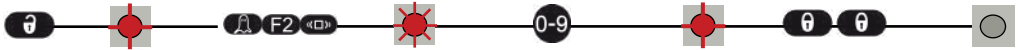

CHECKING A VALUE



x = number of flashes = value of the parameter

$2x$ $1x$ $3x$ $1x$ $5x$ = field width: 2.35 m

RESTORING TO FACTORY VALUES



DETECTION FIELDS

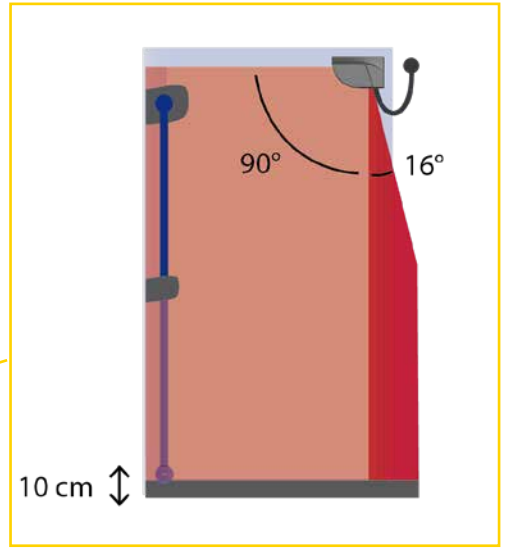
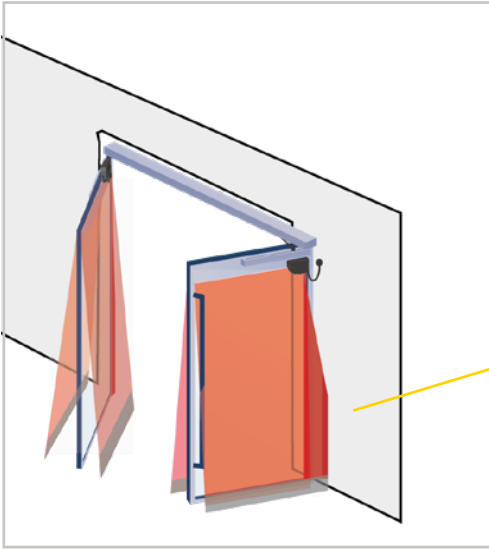

 DOOR WING SAFETY
Typ. object size: 10 cm at 4 m

 HINGE ZONE SAFETY
Typ. object size: 2 cm at 4 m

 UNCOVERED ZONE
Adjustable by remote control
factory value: 10 cm

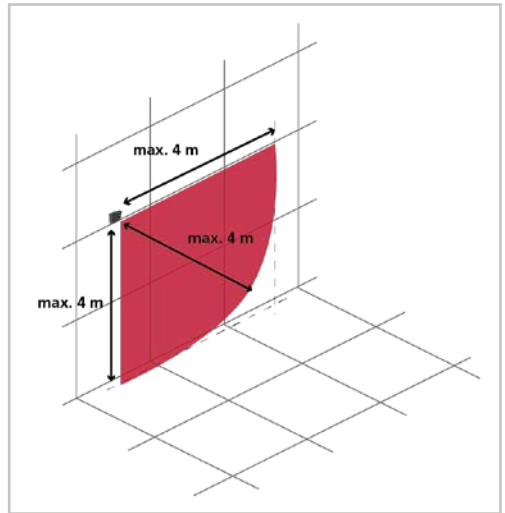
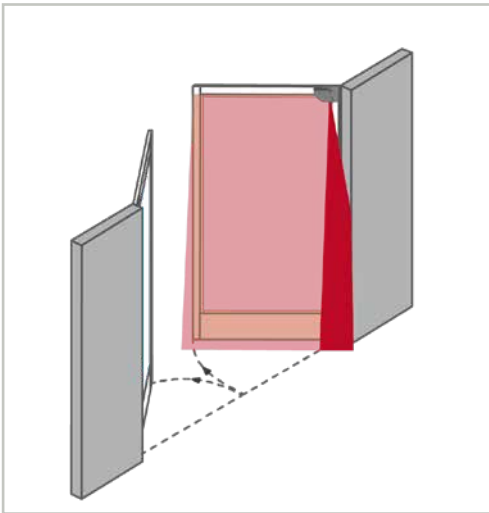

Check the detection fields using our online sizer tool:
bea-flatscan.com/sizer







TROUBLESHOOTING



In case of unwanted reactions of the door, verify whether the problem is caused by the sensor, the door controller or a radar sensor in proximity. To do so, activate the service mode (no safety) and launch a door cycle. If the door cycle is completed successfully, check the sensor. If not, verify the door controller, the wiring or a radar sensor.

Keep a minimum distance of 15 cm between the FLATSCAN and radar sensors or use the *LZR®-FLATSCAN Protective cover* to avoid unwanted reactions of the door.

 	The RED or GREEN LED is ON sporadically or permanently and the door does not react as expected.	Bad teach-in	Launch a new teach-in (closed door).
		Unwanted detections (due to environment or external conditions)	1 Make sure the flexible cable does not cause detections.
			2 Verify if the laser window is dirty and clean it with compressed air. Then wipe it carefully with a damp and clean microfibre cloth if necessary (attention: the surface of the laser window is delicate)
			3 Launch a new teach-in (closed door).
		4 Increase the immunity	
	The sensor does not react at power-on.	Inverted power supply	Check wiring (green +, brown -).
		Faulty cable	Replace cable
		Faulty sensor	Replace sensor
	The sensor does not react when powered.	Service mode is activated	Press the push button during at least 3 seconds to exit the service mode.
	The remote control does not react.	The sensor is protected by a password.	Enter the right password. If you forgot the code, cut and restore the power supply to access the sensor without entering a password during 1 minute.

	The ORANGE LED is on permanently.	The sensor encounters a memory problem.		Send the sensor back for a technical check-up.	
	The ORANGE LED flashes quickly.	DIP-switch setting awaiting confirmation.		Cut and restore power to confirm the DIP-switch setting	
	The ORANGE LED flashes 1 x every 3 seconds.	The sensor signals an internal fault.		Cut and restore power supply. LED flashes again, replace sensor.	
	The ORANGE LED flashes 2 x every 3 seconds.	Power supply is out of limit.	1	Check power supply (voltage, capacity).	
			2	Reduce the cable length or change cable.	
	The ORANGE LED flashes 3 x every 3 seconds.	Internal temperature is too high.		Protect the sensor from any heat source (sun, hot air...)	
			Communication error : several sensors have the same address		Check DIP switch position and validate
			Communication error : door position information missing		Check that the door controller is communicating the door position to the sensor
	The ORANGE LED flashes 4 x every 3 seconds.	Communication error : wiring		Check wiring between interface card and laser head	
			The sensor does not see its background.		Deactivate background.
			Something close to the sensor is masking part of the detection field.	1	Make sure the laser window is not scratched. If it is, replace sensor.
2	Remove all masking elements (insects, spider web, flexible tube, window protection).				
3	Verify if the laser window is dirty and clean it with compressed air. Then wipe it carefully with a damp and clean microfibre cloth if necessary (attention: the surface of the laser window is delicate)				
4	Switch antimasking setting to off (attention: no conformity to DIN 18650 or EN 16005).				
	The ORANGE LED flashes 5 x every 3 seconds.	Teach-in error	1	Check whether all teach-in requirements are fulfilled (see page 8) and launch a new teach-in (closed door).	
			2	Adjust the tilt angle of the laser curtain and launch a new teach-in (closed door).	
			3	Adjust the field dimensions by remote control. Push  and activate a door opening (step 3 of teach-in).	
		Permanent faulty measurements of door position.	1	Launch a new teach-in (closed door).	
			2	If orange LED flashes again, contact BEA.	
	The ORANGE LED flashes 6 x every 3 seconds.	Sporadic faulty measurements of door position.	1	Clear field and wait until the door closes.	
			2	If the door does not close, cut power supply and restore it once the door is fully closed.	
			3	Launch a new teach-in (closed door).	

TECHNICAL SPECIFICATIONS

Technology	LASER scanner, time-of-flight measurement
Detection mode	Presence
Max. detection range	4 m (diagonal) (i.e. : at W = 1.5m -> max. H = 3.7 m)
Field of view	Door wing safety: 90° / Hinge zone safety: 16°
Resolution	Door wing safety: 70 spots (1.3° between spots) / Hinge zone safety: 100 spots (0.2° between the spots)
Typ. min. object size	Door wing safety Hinge zone safety
	10 cm @ 4m (in proportion to object distance, environment presetting = standard) 2 cm @ 4m (in proportion to object distance, environment presetting = standard)
Testbody	700 mm × 300 mm × 200 mm (testbody CA according to EN 16005 & DIN 18650)
Optical characteristics (IEC/EN 60825-1:2014)	IR LASER: wavelength 905 nm; output power < 0.1mW; Class 1
Supply voltage*	12 - 24 V DC ± 15 %
Power consumption	≤ 2 W
Response time	Door wing safety: max. 50 ms / Hinge zone safety: max. 90 ms
LED-signals	1 bi-coloured LED: detection/output status
Dimensions	142 mm (L) × 85 mm (H) × 33 mm (D) (mounting base + 7 mm)
Material - Colour	PC/ASA - Black - Aluminum - White
Tilt angles	+2° to +10° (without mounting base)
Protection degree	IP54 (IEC/EN 60529)
Temperature range	-30°C to +60°C if powered
Humidity	0-95 % non-condensing
Vibrations	< 2 G
Communication interface	CAN
Conformity	EN 12978; EN ISO 13849-1 Pl "d"/ CAT2; EN 62061 SIL 2. DIN 18650-1 (testbody CA). EN 16005 (testbody CA).

* External electrical sources must be within specified voltages, max 15W and ensure double insulation from primary voltages.

Specifications are subject to change without prior notice.
All values measured in specific conditions.



BEA SA | UEGE Science Park | Allée des Noisetiers, 5 - 4031 ANGLEUR [BELGIUM] | T +32 4 361 65 65 | F +32 4 361 28 58 | info-eu@beasensors.com | www.beasensors.com



BEA hereby declares that the LZR®-FLATSCAN SW CAN is in conformity with directives 2014/30/EU (EMC), 2006/42/EC (Machinery) and 2011/65/EU (RoHS). The complete declaration of conformity is available on our website.

Notified Body for EC-type inspection: 0044 - TÜV NORD CERT GmbH, Langemarckstr. 20, D-45141 Essen.

EC-type examination certificate number: 44 205 13089640.

Estelle Graas, Angleur, August 2021.



The complete declaration of conformity is available on our website

This product should be disposed of separately from unsorted municipal waste.