

LZR®-FLATSCAN W

SAFETY SENSOR FOR AUTOMATED WINDOWS

User's Guide for product version 0103 and higher
(refer to tracking label on product)



INSTALLATION TIPS

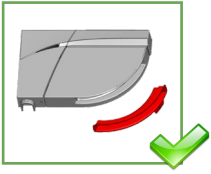

Remove the laser window protection before the commissioning of the sensor.

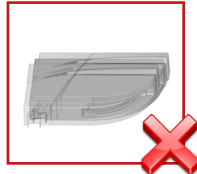

Avoid vibrations.

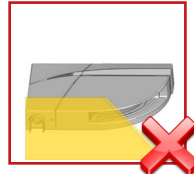

Do not cover the laser window.

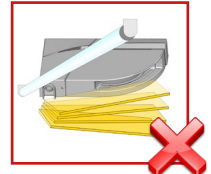

Avoid moving objects and light sources in the detection field.



Avoid the presence of smoke and fog in the detection field.

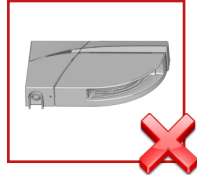

Avoid condensation.

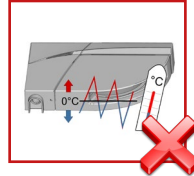

Avoid exposure to sudden and extreme temperature changes.

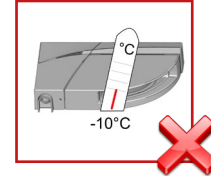

Keep the sensor permanently powered in environments where the temperature can descend below -10°C.

MAINTENANCE TIPS

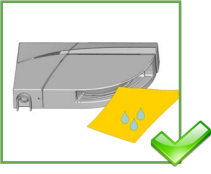

Clean the laser window with compressed air. If needed, wipe only with a soft, clean and damp microfiber cloth.



Do not use dry or dirty towels or aggressive products to clean the laser window.

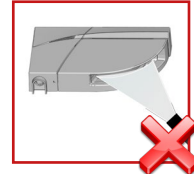

Avoid direct exposure to high pressure cleaning.

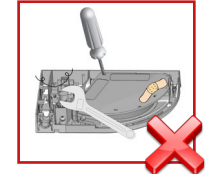

The warranty is invalid if unauthorized repairs are made or attempted by unauthorized personnel.

SAFETY TIPS

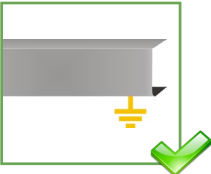

The controller and the supports must be correctly grounded.



Only trained and qualified personnel may install and setup the sensor.



Always test the good functioning of the installation before leaving the premises.

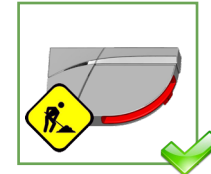

Do not remove the laser window protection when building works are still in progress on site.

-  The device cannot be used for purposes other than its intended use. All other uses cannot be guaranteed by the manufacturer of the sensor.
- The provider of the complete automated window system is responsible for risk assessment and for compliance of the system with applicable national and international regulations.
- The manufacturer of the sensor cannot be held responsible for incorrect installations or inappropriate adjustments of the sensor.

DESCRIPTION





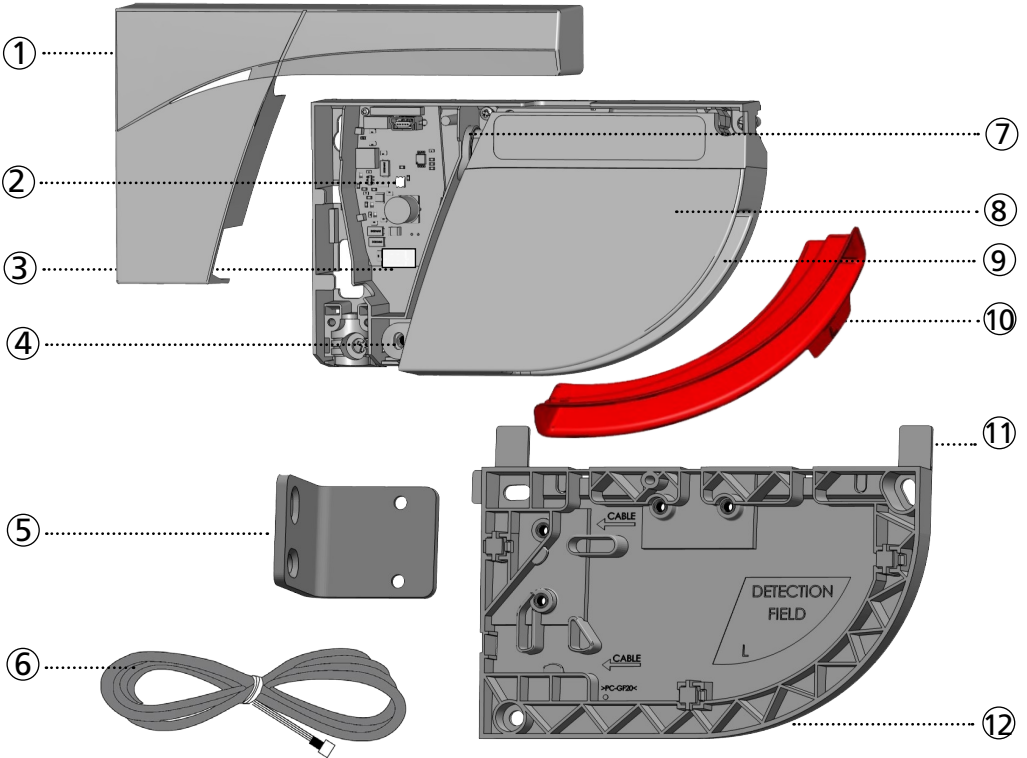



The LZR®-FLATSCAN W is a safety sensor for automatic windows based on laser technology. It must be installed in the upper corner of the window. It covers the window with a diagonal line of 4m.



- | | |
|---------------------------|---------------------------------|
| 1. cover | 7. lock screw |
| 2. LED | 8. laser head |
| 3. main connector | 9. laser window |
| 4. angle adjustment screw | 10. laser window protection cap |
| 5. mounting bracket | 11. positioning aids |
| 6. power cable | 12. mounting base |

LED SIGNAL

- | | |
|--|--|
|  1. Laser head initialisation |  Output relay 1 activated (opening) |
|  1. Calculation in progress |  Define detection zone |
|  2. Exit the zone and wait |  Errors |

! OPENING AND CLOSING THE SENSOR

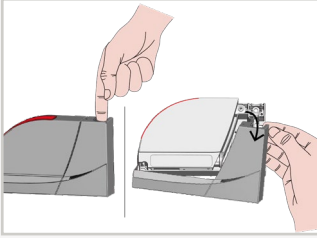

- Remove the sensors' cover:
1. Put your finger in the hole
 2. Pull firmly towards you in one movement.

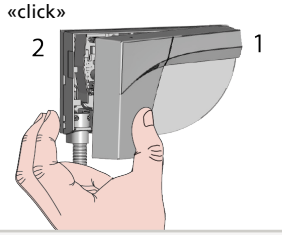

Close the cover starting on the narrow side (1). Do not hesitate to push (2).

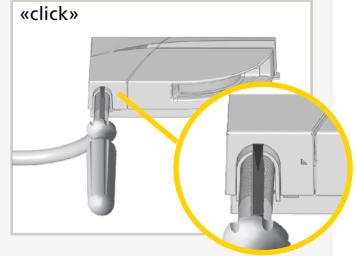

To open the sensor once fixed, position a screwdriver in the notch and pull upwards until the cover comes loose.



Make sure you always fasten the lock **firmly** to avoid vibrations !

1 MOUNTING THE SENSOR

SURFACE MOUNTING

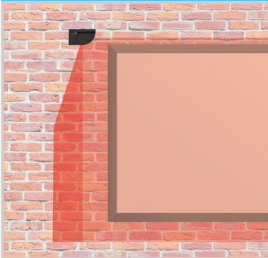

NICHE MOUNTING

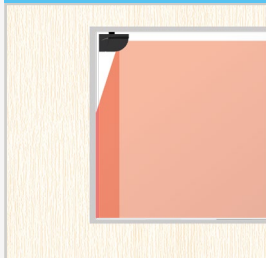

NICHE MOUNTING

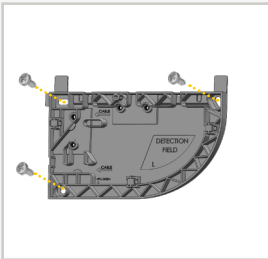
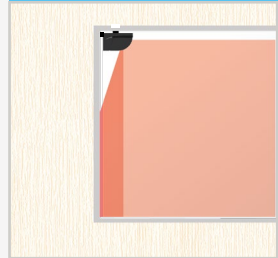

TOP FIXATION

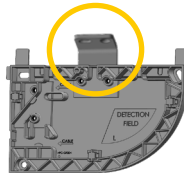

LATERAL FIXATION

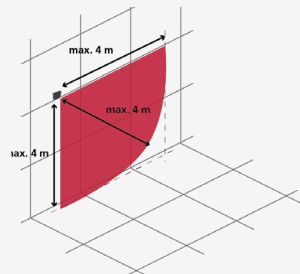
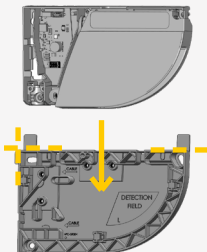
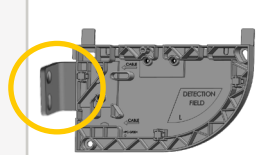

2 WIRING TO WINDOW CONTROLLER

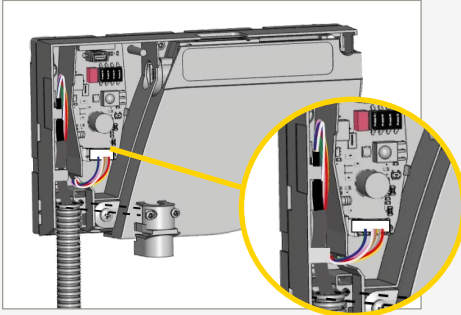

Make a loop with the wires of the power cable and pass them through the notch as indicated. Block the cable behind the notches.

You can use the flexible cable to guide the cable.

! For compliance with safety standards, the test output must be connected and the window controller must be monitoring the sensor.

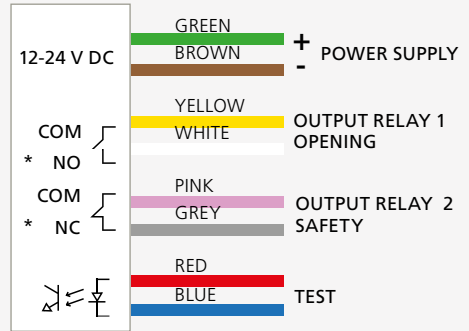

* See OUTPUT CONFIGURATION setting

Cut the power cable to the right length, strip the 8 wires and connect all wires as indicated. The polarity of the power supply must be respected!

3 ADJUSTING CURTAIN ANGLE

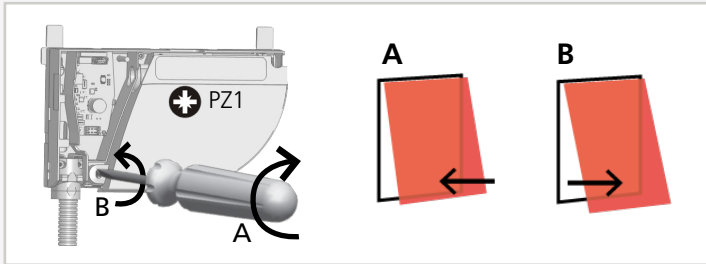

If necessary, adjust the tilt angle of the laser curtain by turning the tilt angle adjustment screw.

4 DIP-SWITCH SETTINGS

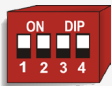

DIP 1 BACKGROUND ANALYSIS

DIP 2 IMMUNITY

DIP 3 OBJECT SIZE

DIP 4 EXTENDED ZONE

ON	OFF	
ON	OFF	ON : The sensor analyses the background located in the detection field. OFF: The sensor works with an uncovered zone of min. 2 cm.
standard	critical	Switch to CRITICAL when external disturbances are likely to cause unwanted detections (increased immunity).
2 cm	6 cm	See MIN. OBJECT SIZE setting
ON	OFF	See DIMENSIONS EXTENDED ZONE setting



ORANGE



OFF

After changing a DIP-switch, the orange LED flashes.
A LONG push on the push button confirms the settings.

5 TEACH-IN



Before launching a teach-in, make sure that:

- the detection field is free of snow buildups, heavy rain, snowfall, fog or other objects.
- the laser window protection cap is removed.
- glass surfaces near the automated window are covered.

1. To launch a teach-in, press the push button briefly or use the remote control.
2. The LED will flash red/green. Wait until it slowly flashes green.
3. Position yourself in front of the window and stretch out your arm in the bottom corner opposite to the sensor in order to define the limit of the detection zone.
4. The LED flashes red while calculating the detection zone. Once the LED is off, the teach-in is complete.

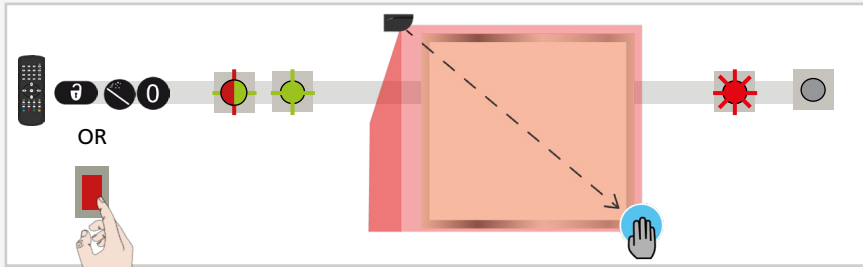

FREE SHAPE TEACH-IN

You can also set the detection field by launching a free shape teach-in. The shape and limit of the detection field is defined by a hand movement. You have 30 sec. to define the detection field with your hand.

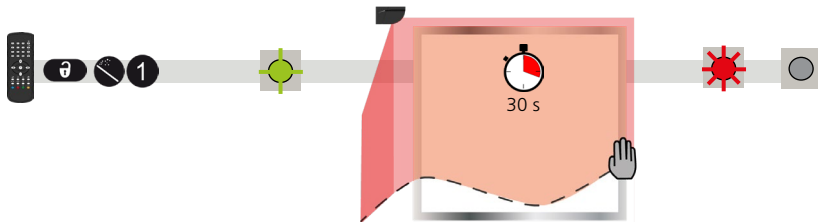

VIRTUAL PUSH BUTTONS

After either one of the previous teach-ins, you can add virtual push buttons (max. 10) in the detection field. They can be used as activation zones to open or close the window manually:

When the green LED flashes, hold your hand in the desired position to learn the virtual push button. The LED flashes red to confirm the teach-in. Remove your hand: when the LED flashes green you can either learn another virtual push button or wait 10 sec. until the end of the teach-in.

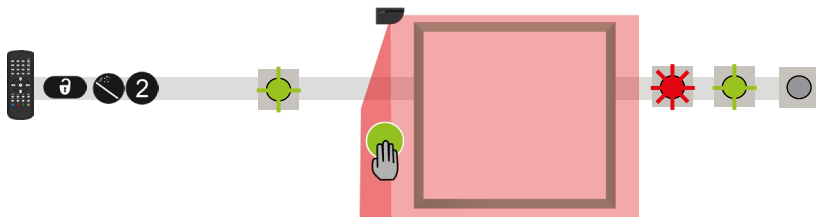

Launch a new teach-in each time the sensor position is changed or objects are added to/changed in the detection zone.

REMOTE CONTROL SETTINGS (OPTIONAL)

DIMENSIONS WINDOW ZONE

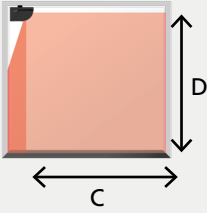

C	0 0 0	0 0 1	-	4 0 0	cm
	no field	001	-	400	
D	0 0 0	0 0 1	-	4 0 0	cm
	no field	001	-	400	

* A teach-in overwrites these values automatically. Resolution: 1 cm

DIMENSIONS EXTENDED ZONE

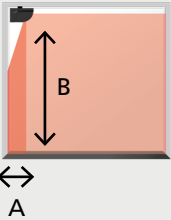

In order to change these settings by remote control, adjust DIP-switch 4 to ON

A	0 0 0	0 0 1	-	1 0 0	100 cm
	no field	001	-	040	
B	0 0 0	0 0 1	-	4 0 0	cm
	no field	001	-	400	

* A teach-in overwrites these values automatically. Resolution: 1 cm

IMMUNITY FILTER

In order to change these settings by remote control, adjust DIP-switch 2 to ON

	1	2	3	4	5	6	7	8	9
low	>	>	>	>	>	>	>	>	high

Increase to filter out external disturbances.

MIN. OBJECT SIZE (indicative values)

In order to change these settings by remote control, adjust DIP-switch 3 to ON

	1	2	3	4	5	6	7	8	9
	2	4	6	8	10	12	14	16	18 cm*

* measured in specific conditions and dependant on application and installation.

UNCOVERED ZONE WHEN BACKGROUND ANALYSIS IS OFF

F2	1	2	3	4	5	6	7	8	9
	2	4	6	8	10	12	14	16	18 cm*

* measured in specific conditions and dependant on application and installation.

FACTORY VALUES

REMOTE CONTROL SETTINGS (OPTIONAL)

OUTPUT CONFIGURATION

	1	2	3	4													
R1 (opening)	NO	NC	NC	NO	<table style="margin-left: 20px;"> <tr> <td></td> <td style="text-align: center;">NO</td> <td style="text-align: center;">NC</td> </tr> <tr> <td>NO POWER</td> <td></td> <td></td> </tr> <tr> <td>NO DETECTION</td> <td></td> <td></td> </tr> <tr> <td>DETECTION</td> <td></td> <td></td> </tr> </table>		NO	NC	NO POWER			NO DETECTION			DETECTION		
	NO	NC															
NO POWER																	
NO DETECTION																	
DETECTION																	
R2 (safety)	NC	NO	NC	NO													

NO = normally open
NC = normally closed

REDIRECTION OF EXTENDED ZONE

	1	2	3
R1		R2	R1+R2

GENERAL

	0	1	2	8	9
	teach-in	teach-in free shape	teach-in virtual push buttons	full reset	partial reset
	see page 6	see page 6	see page 6	Factory reset of all values	Factory reset of all values except field dimensions & output configurations

STANDBY MODE

	0	1
	OFF	ON



STANDBY MODE

The sensor offers a standby mode that temporarily pauses the motor rotation and the laser emission. To enter standby mode, remove test input voltage (red/blue wires) during more than 5 seconds. The standby mode will be maintained until the test input voltage is restored.



Note that the safety field and virtual push button are inoperative in standby mode !



SERVICE MODE

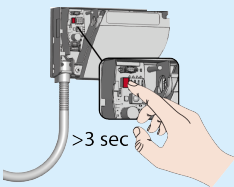

The service mode deactivates the safety detection during 15 minutes and can be useful during an installation, a mechanical teach-in of the window or maintenance work.

To enter the service mode, push on the button for at least 3 seconds. When the sensor is in service mode, the LED is off. To exit the service mode, push again for at least 3 seconds.

The service mode is automatically deactivated when launching a teach-in.



FACTORY VALUES

HOW TO USE THE REMOTE CONTROL



After unlocking, the red LED flashes and the sensor can be adjusted by remote control.



If the red LED flashes quickly after unlocking, you need to enter an access code from 1 to 4 digits. If you do not know the access code, **cut and restore the power supply**. During 1 minute, you can access the sensor without introducing any access code.



To end an adjustment session, always lock the sensor.



It is recommended to use a different access code for each module in order to avoid changing settings on both modules at the same time. The access code is recommended for sensors installed close to each other.

SAVING AN ACCESS CODE



DELETING AN ACCESS CODE



Enter the existing code

ADJUSTING ONE OR MORE PARAMETERS

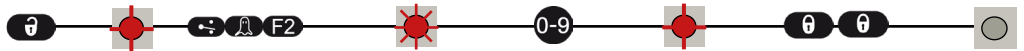

CHECKING A VALUE



x = number of flashes = value of the parameter

Example: = field width: 2.35 m

RESTORING TO FACTORY VALUES



TROUBLESHOOTING

 In case of unwanted reactions of the window, verify whether the problem is caused by the sensor or the controller. To do so, activate the service mode (no safety) and start an opening or closing cycle. If the window opens and/or closes, check the sensor. If not, verify the controller or the wiring.

 	The RED or GREEN LED is ON sporadically or permanently and the window does not react as expected.	Unwanted detections (due to environment changes or external conditions)	1	Make sure the flexible cable does not cause detections.
			2	Has there been changes in the environment? New objects ?
			3	Verify if the laser window is dirty and clean it with compressed air. Then wipe it carefully with a damp and clean microfibre cloth if necessary (attention: the surface of the laser window is delicate)
			4	Launch a new teach-in.
			5	Switch DIP 2 to off (critical environment).
	The sensor does not react at power-on.	Inverted power supply	Check wiring (green +, brown -).	
		Faulty cable	Replace cable	
		Faulty sensor	Replace sensor	
The sensor does not react when powered.	Test error	Check voltage between red and blue wires (test entry)		
	The service mode is activated.	Press the push button during at least 3 seconds to exit the service mode.		
	Standby mode is activated.	Check voltage between red and blue wires (test entry)		
	It is not possible to adjust a setting by remote control.	Wrong DIP-switch position.	Adjust the required DIP-switches to ON.	
		The sensor is protected by a password.	Enter the right password. If you forgot the code, cut and restore the power supply to access the sensor without entering a password during 1 minute.	

TROUBLESHOOTING

	The ORANGE LED is on permanently.	The sensor encounters a memory problem.		Send the sensor back for a technical check-up.
	The ORANGE LED flashes quickly.	DIP-switch setting awaiting confirmation.		Confirm the DIP-switch setting: long push on the push button.
 1	The ORANGE LED flashes 1 x every 3 seconds.	The sensor signals an internal fault.		Cut and restore power supply. LED flashes again, replace sensor.
 2	The ORANGE LED flashes 2 x every 3 seconds.	Power supply is out of limit.	1	Check power supply (voltage, capacity).
		Internal temperature is too high.	2	Reduce the cable length or change cable.
				Protect the sensor from any heat source (sun, hot air...)
 3	The ORANGE LED flashes 3 x every 3 seconds.	Communication error		Check internal wiring between interface card and laser head.
 4	The ORANGE LED flashes 4 x every 3 seconds.	Something close to the sensor is masking part of the detection field.	1	Remove all masking elements (insects, spider web, flexible tube, window protection).
			2	Verify if the laser window is dirty and clean it with compressed air. Then wipe it carefully with a damp and clean microfibre cloth if necessary (attention: the surface of the laser window is delicate)
			3	Check if there are scratches on the laser window. If it is the case, replace sensor.
 5	The ORANGE LED flashes 5 x every 3 seconds.	Teach-in error	1	Check whether all teach-in requirements are fulfilled and launch a new teach-in.
			2	Adjust the tilt angle and launch a new teach-in.

TECHNICAL SPECIFICATIONS

Technology	LASER scanner, time-of-flight measurement, background analysis
Detection mode	Presence
Max. detection range	4 m (diagonal) (i.e. : at W = 3.7 m -> max. H = 1.5 m)
Number of curtains	1
Measurements points	400
Angular resolution	0,27°
Angular coverage	110 °
Min. object size	2 cm (depending on the settings and the installation)
Optical characteristics (IEC 60825-1)	IR LASER: Wavelength 905 nm; output power < 0.1mW; Class 1
Supply voltage	12-24V DC ± 15% (The Equipment must be powered by a SELV limited power source ensuring double insulation between primary voltages and the Equipment supply. The supply current should be limited to 1.5A.)
Power consumption	≤ 2 W
Typ. response time	400 ms
Peak current at power-on	0.8A (max. 20 ms @ 24 VDC)
Cable length	5 m
Output Max. switching voltage Max. switching current	2 solid state relays (galvanic isolation - polarity free) 42V AC/DC 100 mA
Input Max. contact voltage Voltage threshold	1 optocoupler (galvanic isolated - polarity free) 30 V DC (over-voltage protected) Log. H: >8 V DC; Log. L: <3 V DC
LED-signals	1 Tri-coloured LED: detection/output status
Dimensions	142 mm (L) × 85 mm (H) × 33 mm (D) (mounting base + 14 mm)
Material - Colour	PC/ASA - Black - Aluminum - White
Tilt angles	-2° to +6° (with mounting base) +2° to +10° (without mounting base)
Protection degree (IEC/EN 60529)	IP54
Temperature range	-30°C to +60°C if powered; -10°C to +60°C without power
Humidity	0-95 % non-condensing
Vibrations	< 2 G
Conformity	EN 12978 ; EN 16005 ; IEC/EN 60335-2-103 EN ISO 13849-1 (PL "d"); IEC/EN 61508 (SIL2)

*Specifications are subject to changes without prior notice.
All values measured in specific conditions.*

BEA SA | LIEGE Science Park | ALLÉE DES NOISETIERS 5 - 4031 ANGLEUR [BELGIUM] | T +32 4 361 65 65 | F +32 4 361 28 58 | INFO@BEA.BE | WWW.BEASENSORS.COM



BEA hereby declares that the LZR@-FLATSCAN W is in conformity with European directives 2014/30/EU (EMC), 2006/42/EC (Machinery) and 2011/65/EU (RoHS).
Notified Body for EC-type inspection: 0044 - TUV NORD CERT GmbH, Langemarkstr. 20, D-45141 Essen
EC-type examination certificate number: 44 205 13089637
Angleur, 2021 Estelle Graas

The complete declaration of conformity is available on our website.

This product should be disposed of separately from unsorted municipal waste

