

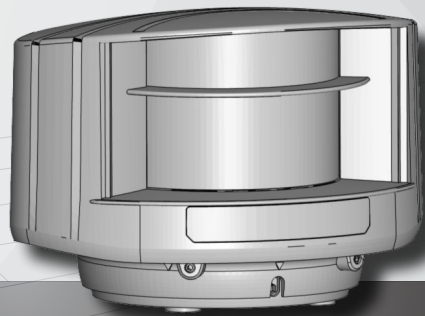

EN



LZR[®]-P220

SAFETY SENSOR
FOR SECURING THE CLOSING EDGE
ON REVOLVING DOORS

User's Guide for software version 0300 and more
(refer to tracking label on product)

This user's guide is an informative document and cannot be seen as a commitment of result.

DESCRIPTION

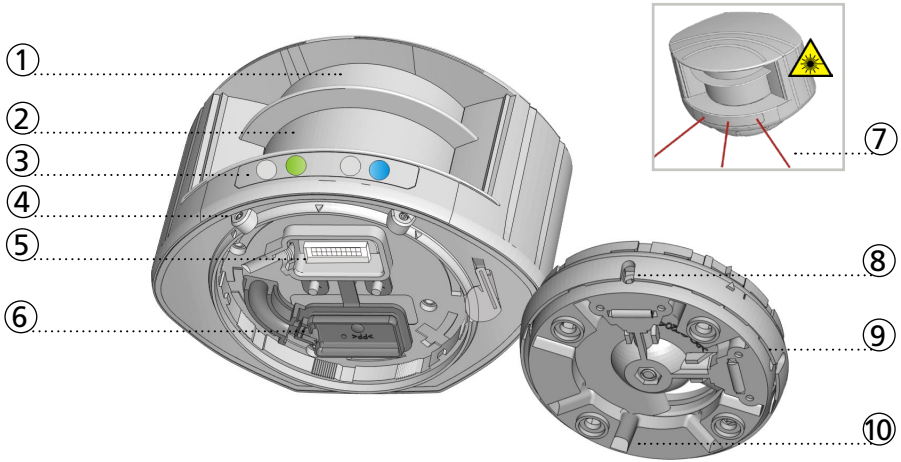

- | | |
|--------------------------------|--|
| 1. laser sweep emission | 6. protection cover |
| 2. laser sweep reception | 7. visible laser beam (3) |
| 3. LED-signal (4) | 8. notch for tilt angle adjustment (2) |
| 4. screw for position lock (2) | 9. adjustable bracket |
| 5. connector | 10. cable conduit (4) |

LED-SIGNAL

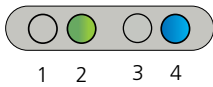

1. Not used
2. Detection LED: safety field
3. Error LED
4. Power LED

DETECTION LED

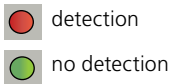

ERROR LED

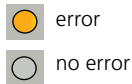

POWER LED

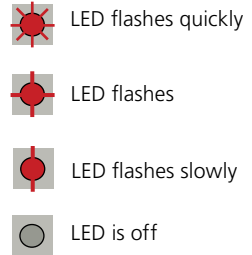
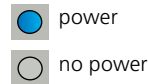

SYMBOLS



Caution!
Laser radiation



Remote control
sequence



Possible
remote control
adjustments



Factory
values

SAFETY



The device emits invisible (IR) and visible laser radiation.
IR laser: wavelength 905 nm; output power <math><0.10\text{ mW}</math> (Class 1 according to IEC 60825-1)
Visible laser: wavelength 635 nm; output power <math><1\text{ mW}</math> (Class 2 according to IEC 60825-1)

The visible laser beams are inactive during normal functioning.
The installer can activate the visible lasers if needed.
Do not stare into visible laser beams.



CAUTION!

Use of controls, adjustments or performance of procedures other than those specified herein may result in hazardous radiation exposure.

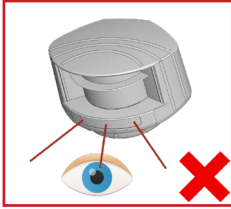

Do not stare into the visible red laser beams.

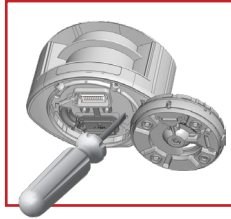

The warranty is void if unauthorized repairs are made or attempted by unauthorized personnel.



Only trained and qualified personnel may install and adjust the sensor.



Test the good functioning of the installation before leaving the premises.

The manufacturer of the door system is responsible for carrying out a risk assessment and installing the sensor and the door system in compliance with applicable national and international regulations and standards on door safety. Other use of the device is outside the permitted purpose and can not be guaranteed by the manufacturer. The manufacturer cannot be held responsible for incorrect installations or inappropriate adjustments of the sensor.

INSTALLATION AND MAINTENANCE

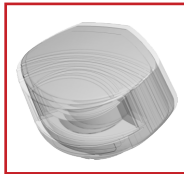

Avoid extreme vibrations.

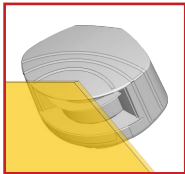

Do not cover the front screens.

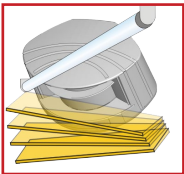

Avoid moving objects and light sources in the detection field.

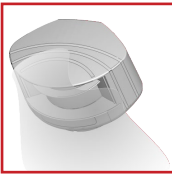

Avoid the presence of smoke and fog in the detection field.

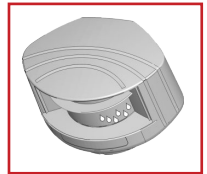

Avoid condensation.

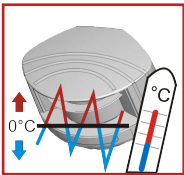

Avoid exposure to sudden and extreme temperature changes.



Avoid direct exposure to high pressure cleaning.



Do not use aggressive products to clean the front screens.

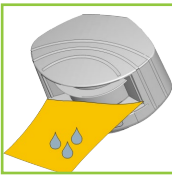

Wipe the front screens regularly with a clean and damp cloth.

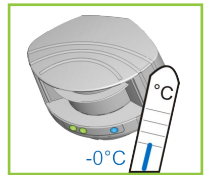

Keep the sensor permanently powered in environments where the temperature can descend below 0°C .

1 MOUNTING

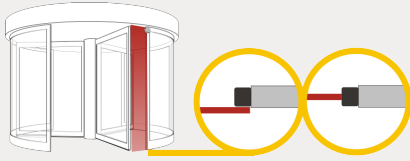

The curtain should be positioned alongside the closing edge.

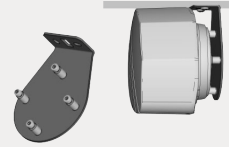

The LBA can be used to mount the sensor to the ceiling.

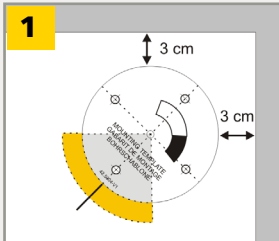

Use the adhesive mounting template to position the sensor correctly. The grey area indicates the detection range.

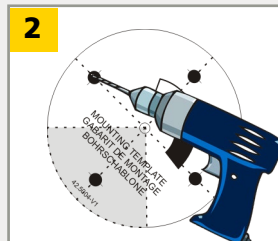

Drill 4 holes as indicated on the mounting template. Make a hole for the cable if possible.

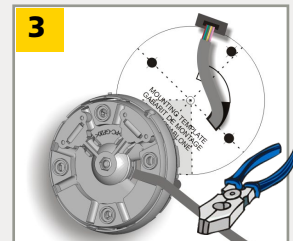

Pass the cable +/- 10 cm through the cable opening. If drilling an opening is not possible, use the cable conduits on the back side of the bracket.

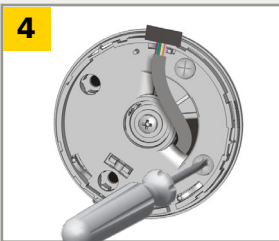

Position the bracket and fasten the 4 screws firmly in order to avoid vibrations.



Open the protection cover, plug the connector and position the cable in the slit.



Close the protection cover and fasten it firmly.

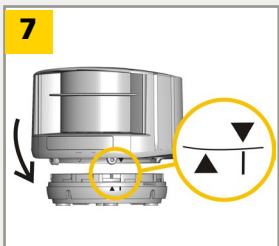

Position the housing on the bracket.

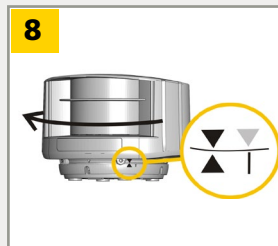

Turn the sensor until the two triangles are face to face.

NEW INSTALLATION - NC

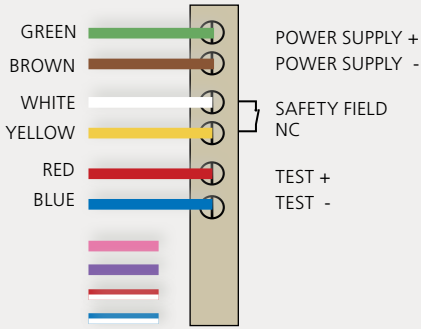

NEW INSTALLATION - NO

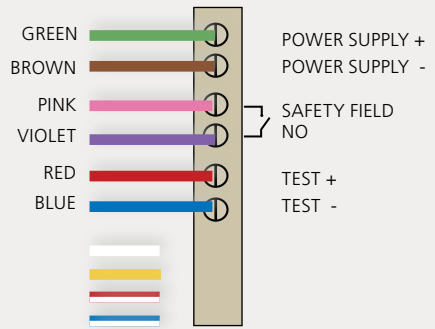

Door control without test: connect red and blue wires to power supply without polarity (excludes conformity with DIN 18650 and EN 16005).

IRIS ON C RETROFIT

If replacing an IRIS ON C sensor, use the retrofit cable kit (sold as accessory) to connect the LZR®-P220 to the IRIS ON C cable.

Depending on the polarity, you need to choose the black or grey cable:

DOOR CONTROLLER

IRIS CABLE

ADAPTER CABLE

LZR®-P220

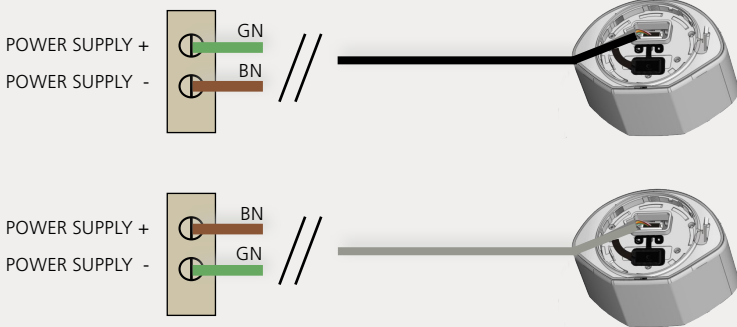

3 POSITIONING



Unlock the sensor and activate the visible laser beams.

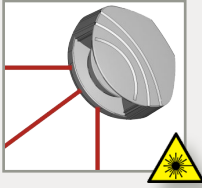

The visible laser beams indicate approximately the position of the first curtain and limit the angle of the detection field.

The visible laser beams stay activated for 15 minutes or can be turned off the same way they were activated.

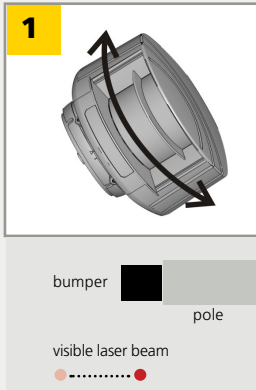

Adjust the **lateral position** of the detection field.

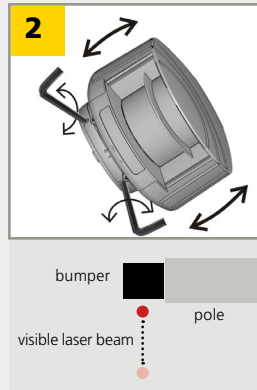

Adjust the **tilt angle** of the detection field with the hex key.

Avoid reflections of the visible laser beam on the pole.

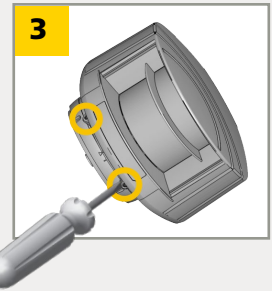

Lock the position of the mounting bracket to avoid malfunctioning in case of extreme vibrations.

4 TEACH-IN

Launch a teach-in to end the installation procedure, after changing the sensor position or when new objects are added to or changed in the detection zone.

The detection field should be free of snow buildups, heavy rain, snowfall, fog or other moving objects.



During teach-in, the sensor learns its surroundings and adapts the detection field shape to these. Objects in the detection field will be cut out.

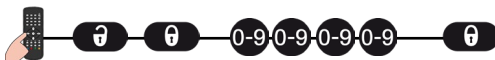

At the end of the installation, enter an access code to avoid vandalism.

IMPORTANT: Test the good functioning of the installation before leaving the premises.

REMOTE CONTROL ADJUSTMENTS (OPTIONAL)

FIELD WIDTH

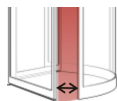

C **0 1 0 - 1 0 0** **0 2 5**

10 cm 100 cm 25 cm

< 20 cm does not allow conformity with EN 16005 / DIN 18650

FIELD HEIGHT

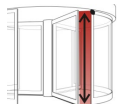

D **0 0 0** **0 1 0 - 5 0 0** **4 0 0**

no safety field 10 cm 500 cm 400 cm

> 400 cm does not allow conformity with EN 16005 / DIN 18650

MOUNTING POSITION

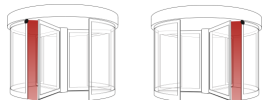

◀ □ ▶ **1** **2** **3** **4**

left right left right

with background without background

UNCOVERED ZONE

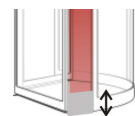

F2 **0** **1** **2** **3** **4**

5 7 9 12 15 cm

Increase in case of snow, dead leaves, etc.

IMMUNITY FILTER



1 **2** **3** **4**

indoor outdoor low outdoor med* outdoor high

*at max. 3 m mounting height (EN 16005 / DIN 18650)

BACKGROUND TRACKING



0 **1**

off on

CHOICE OF CURTAIN

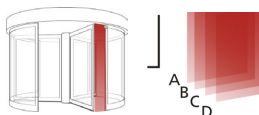

1 **2** **3** **4**

A B C D

The visible laser beams ● indicate approximately the position of the first curtain (A). The distances between the curtains depend on the mounting height (see table with estimated values measured from spot centre to spot centre and mounted on the right side). Locate the exact position of the curtain by testing the detection behaviour.

	2 m	3 m	4 m	5 m
A-B	3 cm	4.5 cm	6 cm	7.5 cm
A-C	6 cm	9 cm	12 cm	15 cm
A-D	9 cm	13 cm	17 cm	21 cm

IMPORTANT!

Always launch a teach-in after any remote control adjustment.
Field width and height are limited by the field dimensions determined by the teach-in.

HOW TO USE THE REMOTE CONTROL



After unlocking, the red LED flashes and the sensor can be adjusted by remote control.



If the red LED flashes quickly after unlocking, you need to enter an access code from 1 to 4 digits.



To end an adjustment session, always lock the sensor.

ADJUSTING ONE OR MORE PARAMETERS

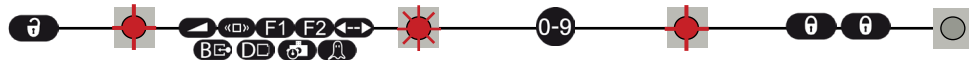

CHECKING A VALUE

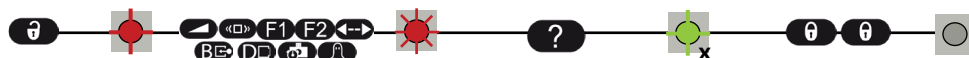

= field width: 4.2 m

= field width is defined by teach-in

RESTORING TO FACTORY VALUES

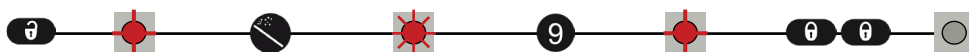

SAVING AN ACCESS CODE

The access code is recommended for sensors installed close to each other.



DELETING AN ACCESS CODE

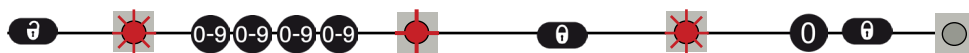

Enter the existing code



X = NUMBER OF FLASHES = VALUE OF THE PARAMETER

TROUBLESHOOTING

	No blue LED	There is no power.	1 Check cable and connexion.
	Only the blue LED is on.	The polarity of the power supply is inverted.	1 Check the polarity of the power supply.
	The detection LED remains green.	The test input is not connected.	1 Check wiring. The RED and BLUE cable have to be connected to the test input or the power supply.
	The detection LED remains red.	The detection field is too small or deactivated.	1 Check the size of the fields. 2 Launch a teach-in.
	The detection LED remains red.	The object size is too small.	1 Decrease the min. object size.
	The orange LED is flashing and the detection LEDs are red.	Someone or something is in the detection field.	1 Step out of the field and/or remove the any object(s) from the field.
	The orange LED is flashing and the detection LEDs are red.	The field is touching the floor, the wall or the door, which leads to detection.	1 Activate the 3 red beams and check if the position of the sensor is correct. If not, adjust the hex screws. 2 Verify the field size. 3 Launch a teach-in.
	The orange LED is flashing and the detection LEDs are red.	No background (reference point) is found.	1 Check the position of the sensor. 2 Check the mounting side setting. If there is no background, set the mounting side to value 3 to 4. 3 Launch a new teach-in.
	The orange LED is flashing and the detection LEDs are red.	The sensor is masked.	1 Verify and clean the front screens with a damp cloth.
	The orange LED is flashing and the detection LEDs are red.	The power supply voltage is exceeding the acceptable limits.	1 Check the power supply voltage.
	The orange LED is flashing and the detection LEDs are red.	The sensor exceeds its temperature limits.	1 Verify the outside temperature where the sensor is installed. Eventually protect the sensor from sunlight using a cover.
	The orange LED is flashing and the detection LEDs are red.	Internal error	1 Wait a few seconds. If the LED remains ON, reset the power supply. If the LED turns on again, replace the sensor.
	The sensor does not respond to the remote control.	The batteries in the remote control are not installed properly or dead.	1 Verify or replace the batteries.
	The sensor does not respond to the remote control.	The remote control is badly pointed.	1 Point the remote control towards the sensor, but with a slight angle. The RC should not be pointed in a right angle in front of the sensor.
	The sensor does not respond to the remote control.	A reflective object is in close proximity to the sensor.	1 Avoid highly reflective material in proximity to the sensor.
	The sensor does not respond to the remote control.	You have to enter an access code or the wrong code was entered.	1 Cut and restore power supply. No code is required to unlock during the first minute after powering.

TECHNICAL SPECIFICATIONS

Technology:	laser scanner, time-of-flight measurement
Detection mode:	motion and presence
Max. detection range:	5 m x 1 m (at max. 4 m according to EN 16005, DIN 18650)
Remission factor:	> 5 % IR laser wavelength
Angular resolution:	0,3516 °
Min. detected object size (typ.):	2,1 cm @ 3 m ; 3,5 cm @ 5 m (in proportion to object distance)
Testbodies:	700 mm x 300 mm x 200 mm (CA according to EN 16005, DIN 18650) Ø 50 mm @ max. 4 m (CB according to DIN 18650)
Emission characteristics:	(IEC/EN 60825-1)
IR laser:	wavelength 905 nm; output power <0.10 mW (CLASS 1)
Red visible laser:	wavelength 635 nm; output power <1 mW (CLASS 2)
Supply voltage:	10-35 V DC @ sensor side (to be operated from SELV compatible power supplies only)
Power consumption:	< 5 W
Peak current at power-on:	2.2 A (max. 22 ms @ 24 V)
Cable length:	5 m
Response time:	typ. 80 ms; max. 150 ms
Output:	1 output NO or NC (galvanic isolated - polarity free)
Max. switching voltage:	35 V DC / 24 V AC
Max. switching current:	80 mA (resistive)
Switching time:	t _{ON} =5 ms; t _{OFF} =5 ms
Output resistance:	typ 30 Ω
Voltage drop on output:	< 0.7 V @ 20 mA
Leakage current:	< 10 µA
Input:	1 optocoupler (galvanic isolated - polarity free)
Max. contact voltage:	30 V DC (over-voltage protected)
Voltage threshold:	Log. H: >8 V DC; Log. L: <3 V DC
Response time monitoring input:	< 5 ms
LED-signal:	1 blue LED: power-on status 1 orange LED: error status 2 bi-coloured LEDs: detection/output status (green: no detection; red: detection)
Dimensions:	125 mm (D) x 93 mm (W) x 70 mm (H) (mounting bracket + 14 mm)
Material:	PC/ASA
Colour:	black
Mounting angles on bracket:	-45 °, 0 °, 45 °
Rotation angles on bracket:	-5 ° to +5 ° (lockable)
Tilt angles on bracket:	-3 ° to +3 °
Protection degree:	IP65
Temperature range:	-30 °C to +60 °C if powered; -10 °C to +60 °C unpowered
Humidity:	0-95 % non-condensing
Vibrations:	< 2 G
Pollution on front screens:	max. 30 %; homogenous
Conformity:	EN 12978; EN ISO 13849-1 Pl "d"/ CAT2; IEC/EN 60825-1; IEC/EN 61496-1; IEC/EN 61496-3 ESPE Type 2; IEC/EN 62061 SIL 2; EN 16005 DIN 18650-1

BEA SA | LIEGE SCIENCE PARK | ALLÉE DES NOISETIERS 5 - 4031 ANGLEUR [BELGIUM] | T +32 4 361 65 65 | F +32 4 361 28 58 | INFO@BEA.BE | WWW.BEA-SENSORS.COM



BEA hereby declares that the LZR®-P220 is in conformity with the European directives 2011/65/EU, 2014/30/EU and 2006/42/EC.

Notified Body for EC inspection: 0044 - TÜV NORD CERT GmbH, Langemarckstr. 20, 45141 D-Essen

EC-type examination certificate number: 44 205 13089626

Angleur, June 2018

Pierre Gardier

The complete declaration of conformity is available on our website.

This product should be disposed of separately from unsorted municipal waste

