

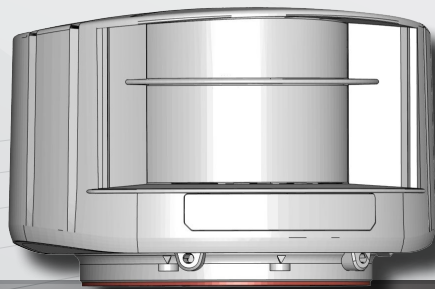

EN



LZR[®] - U920/-U921

LASER MEASUREMENT DEVICE
WITH BIDIRECTIONAL BUS COMMUNICATION

User's Guide for software version 0500 and higher

(refer to tracking label on product)

LASER MEASUREMENT DEVICE

Other use of the device is outside the permitted purpose and can not be guaranteed by the manufacturer.
The manufacturer cannot be held responsible for incorrect installations or inappropriate adjustments of the device.

DESCRIPTION

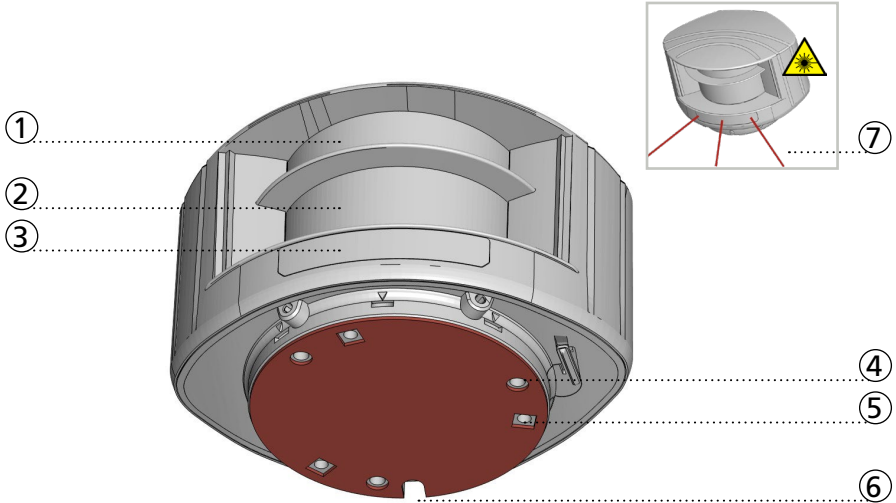

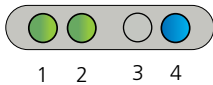

- | | |
|--------------------------|--------------------------------|
| 1. laser sweep emission | 4. holes for M5 screws |
| 2. laser sweep reception | 5. holes for Ø UNC N°10 screws |
| 3. LED-signal (4) | 6. cable conduit |
| | 7. visible laser beams (3) |

LED-SIGNAL





1 2 3 4

LED 1

-  LZR is switched ON and running
-  LZR is in configuration mode

LED 2



-  LZR is transmitting distance data
-  LZR is idle and transmits heartbeat message

1. LED 1
2. LED 2
3. Error LED
4. Power LED

ERROR LED

-  error
-  no error

POWER LED

-  power
-  no power

1 MOUNTING

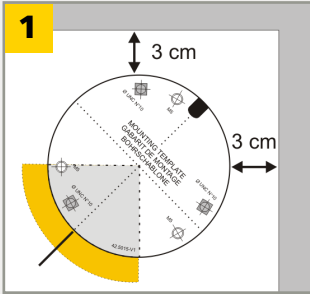

Use the adhesive mounting template to position the sensor correctly. The grey area indicates the measurement range.

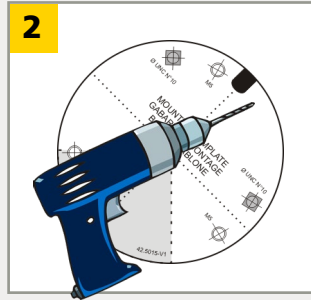

Drill 3 holes as indicated on the mounting template. Make a hole for the cable.



Pass the cable through the cable opening.

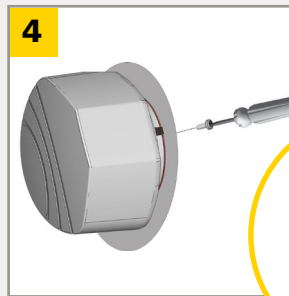

Use M5 or Ø UNC N°10 screws for fixing.

Position the sensor and fasten the screws firmly.

2 WIRING

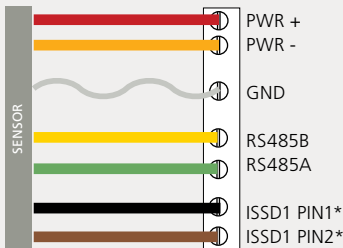

* If the heartbeat mode¹ via the black and brown wire is not used, it is recommended to ground these wires.

TECHNICAL SPECIFICATIONS

Technology:	laser scanner, time-of-flight measurement
Measurement range:	max 65 m 10 m @ 2% remission factor, 30 m @ 10% remission factor
Number of planes:	LZR®-U920: max. 4*; LZR®-U921: 1
Number of points/plane:	max. 274*
Angular resolution:	min. 0.3516 °*
Angular coverage:	max. 96 °*
Rotating speed:	900 turns/min
Scanning frequency:	LZR®-U920: 15 Hz; LZR®-U921: 60 Hz
Remission factor:	> 2 %
Laser emission characteristics: (IEC/EN 60825-1)	wavelength 905 nm; output power <0.10 mW (CLASS 1) wavelength 635 nm; output power <1 mW (CLASS 2)
Supply voltage:	10-35 V DC @ sensor side (to be operated from SELV compatible power suppliers only)
Power consumption:	< 5 W
Peak current at power-on:	1.8 A (max. 80 ms @ 35 V)
Serial communication:	see AN LZR®-U920/-U921 Protocol (available for download on our website)
Type	asynchronous
Interface	RS 485
Communication mode	half-duplex
Transmission speed	460800 bit/sec (max: 921600 bit/sec)
Topology	point to point
Symbol coding	1 start bit, 1 stop bit, no parity bit
File type	8 bits
Cable length:	3 m
Input:	1 optocoupler (galvanic isolated - polarity free)
Max. contact voltage:	30 V DC (over-voltage protected)
Voltage threshold:	Log. H: >8 V DC; Log. L: <3 V DC
LED-signal:	2 bi-coloured LEDs: function status; 1 blue LED: power-on status; 1 orange LED: error status
Dimensions:	125 mm (D) x 93 mm (W) x 76 mm (H)
Material:	PC/ASA
Colour:	black
Protection degree:	IP65
Temperature range:	-30 °C to +60 °C if powered; -10 °C to +60 °C unpowered
Humidity:	0-95 % non-condensing
Vibrations:	< 2 G
Pollution on front screens:	max. 30 %; homogenous
Conformity:	IEC 60825-1 EN 61000-6-2 EMC - Industrial level - immunity EN 61000-6-3 EMC - Commercial level - emission

Specifications are subject to changes without prior notice.
All values measured in specific conditions.

* These parameters can be configured via the RS 485 communication interface.
For more information on the existing options, see AN LZR®-U920/-U921 Protocol.

PARAMETER ADJUSTMENT

For more information on the existing parameters that can be configured, see AN LZR®-U920/-U921 Protocol.

SAFETY



The device emits invisible (IR) and visible laser radiations.
IR laser: wavelength 905nm; output power <math><0.10\text{ mW}</math>
(Class 1 according to IEC 60825-1)
Visible laser: wavelength 635nm; output power <math><1\text{ mW}</math>
(Class 2 according to IEC 60825-1)

The visible laser beams are inactive during normal functioning.
The user can activate the visible lasers if needed. Do not stare into the visible beams.
For more information see application note LZR®-U920-U921 Protocol.



CAUTION!

Use of controls, adjustments or performance of procedures other than those specified herein may result in hazardous radiation exposure.

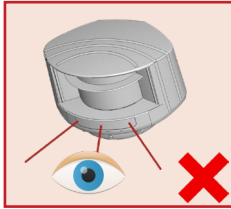

Do not stare into the visible laser beams.

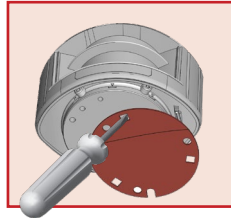

The warranty is void if unauthorized repairs are made or attempted by unauthorized personnel.



Only trained and qualified personnel may install and adjust the sensor.

INSTALLATION AND MAINTENANCE

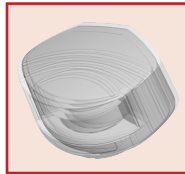

Avoid extreme vibrations.

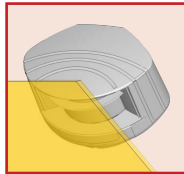

Do not cover the front screens.

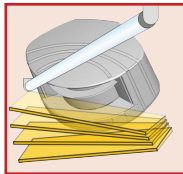

Avoid moving objects and light sources in the measurement field.

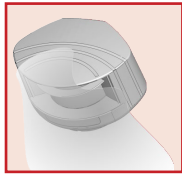

Avoid the presence of smoke and fog in the measurement field.

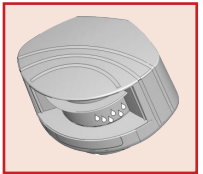

Avoid condensation.

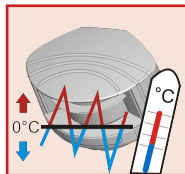

Avoid exposure to sudden and extreme temperature changes.



Avoid direct exposure to high pressure cleaning.



Do not use aggressive products to clean the front screens.

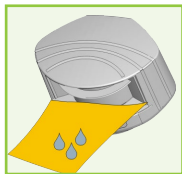

Wipe the front screens regularly with a clean and damp cloth.

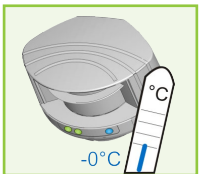

Keep the sensor permanently powered in environments where the temperature can descend below 0°C.



BEA SA | LIEGE Science Park | ALLÉE DES NOISETIERS 5 - 4031 ANGLEUR (BELGIUM) | T +32 4 361 65 65 | F +32 4 361 28 58 | INFO@BEA.BE | WWW.BEA-SENSORS.COM



BEA hereby declares that the LZR®-U920/-U921 is in conformity with the European directives 2011/65/EU and 2014/30/EU.



The complete declaration of conformity is available on our website

This product should be disposed of separately from unsorted municipal waste