

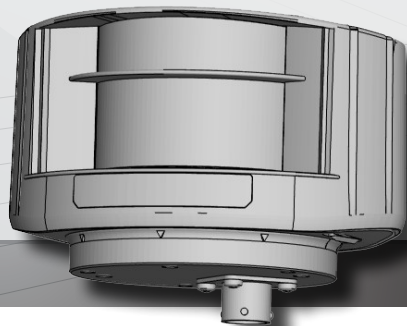

EN



LZR[®] - U903/-U904

LASER MEASUREMENT DEVICE

User's Guide for product version 0300 and more

LASER MEASUREMENT DEVICE

Other use of the device is outside the permitted purpose and can not be guaranteed by the manufacturer. The manufacturer cannot be held responsible for incorrect installations or inappropriate adjustments of the sensor.

SAFETY

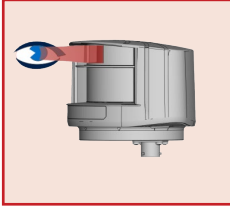

Do not look into the laser emitter.

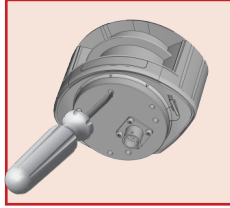

The warranty is void if unauthorized repairs are made or attempted by unauthorized personnel.



Only trained and qualified personnel may install and adjust the sensor.



CAUTION!

Use of controls, adjustments or performance of procedures other than those specified herein may result in hazardous radiation exposure.

INSTALLATION AND MAINTENANCE

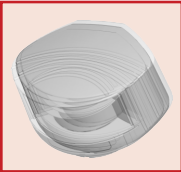

Avoid extreme vibrations.

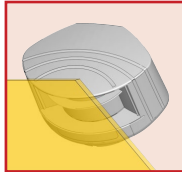

Do not cover the front screens.

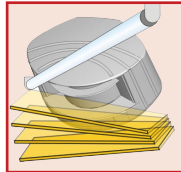

Avoid moving objects and light sources in the detection field.

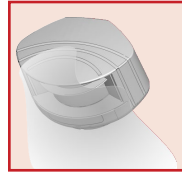

Avoid the presence of smoke and fog in the detection field.

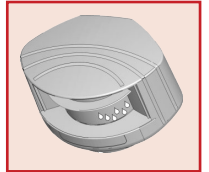

Avoid condensation.

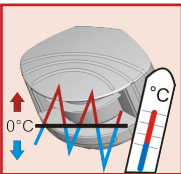

Avoid exposure to sudden and extreme temperature changes.

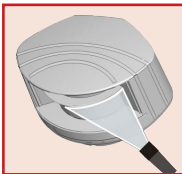

Avoid direct exposure to high pressure cleaning.



Do not use aggressive products to clean the front screens.

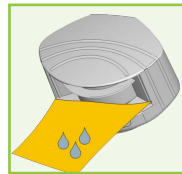

Wipe the front screens regularly with a clean and damp cloth.

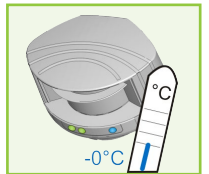

Keep the sensor permanently powered in environments where the temperature can descend below 0°C.

DESCRIPTION

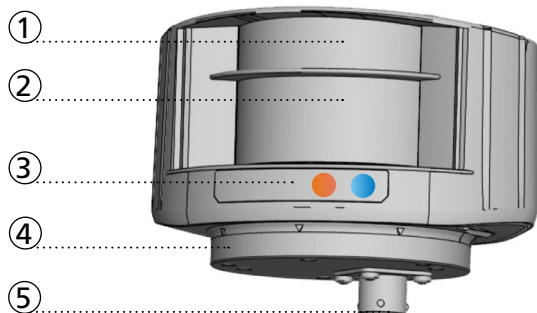

1. laser sweep emission
2. laser sweep reception
3. LED-signal (2)
4. mounting bracket
5. connector



WIRING & FIXING

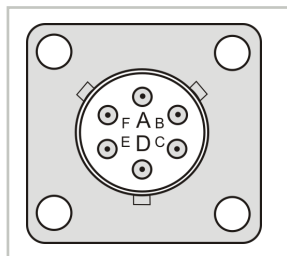

A = power supply +
 B = power supply -
 C = RS485 GND
 D = RS485 B
 E = RS485 A
 F = input 1 (activation of stand-by mode)

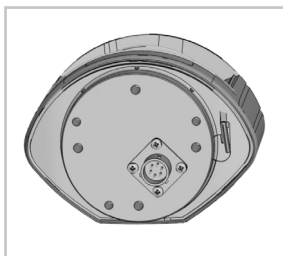

Connector type:
 10-13T Souriau TR
 851 02E 10-6 P50

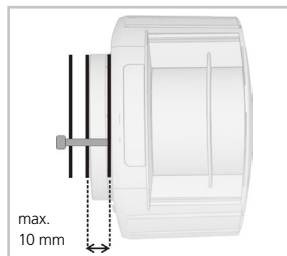

Use M6 screws for fixing.

CAUTION!
 Do not exceed the max.
 penetration depth.

TROUBLESHOOTING

No blue LED	There is no power.	1 Check cable and connexion.
	The polarity of the power supply is inverted.	1 Check the polarity of the power supply.
The orange LED is on.	The power supply voltage is exceeding the acceptable limits.	1 Check the power supply voltage.
	The sensor exceeds its temperature limits.	1 Verify the outside temperature where the sensor is installed. Eventually protect the sensor from sunlight using a cover.
	Internal error	1 Wait a few seconds. If the LED remains ON, reset the power supply. If the LED turns on again, replace the sensor.

TECHNICAL SPECIFICATIONS

Technology:	laser scanner, time-of-flight measurement
Measurement range:	max 50 m 10 m @ 2% remission factor, 30 m @ 10% remission factor
Number of planes:	4
Number of points/plane:	U903: 274; U904: 27
Angular resolution:	U903: 0.352 °; U904: 3.567 °
Angular coverage:	96.3281 °
Rotating speed:	900 turns/min
Remission factor:	> 2 %
Laser emission characteristics:	wavelength 905 nm; max. output pulse power 75 W (CLASS 1)
Supply voltage:	10-35 V DC @ sensor side
Power consumption:	< 5 W
Peak current at power-on:	1.8 A (max. 80 ms @ 35 V)
Serial communication:	see application note LZR®-90X Protocol (available for download on our website)
Type	asynchronous
Interface	RS 485
Communication mode	half-duplex
Transmission speed	U903: 460800 bit/sec; U904: 57600 bit/sec
Topology	point to point
Symbol coding	1 start bit, 1 stop bit, no parity bit
File type	8 bits
LED-signal:	1 blue LED: power-on status; 1 orange LED: error status
Dimensions:	125 mm (D) x 93 mm (W) x 70 mm (H)
Mounting bracket + connector:	11 mm + 2 mm
Material:	PC/ASA; stainless steel
Colour:	black
Mounting angles on bracket:	-45 °, 0 °, 45 °
Rotation angles on bracket:	-5 ° to +5 ° (lockable)
Tilt angles on bracket:	-3 ° to +3 °
Protection degree:	IP65
Temperature range:	-30 °C to +60 °C if powered; -10 °C to +60 °C unpowered
Humidity:	0-95 % non-condensing
Vibrations:	< 2 G
Pollution on front screens:	max. 30 %; homogenous
Expected lifetime:	8 years
Conformity:	2014/35/EU: LVD; 2011/65/EU: RoHS; 2014/30/EU: EMC EN 50155; EN 60529; IEC 60825-1 Laser Class 1; EN 60950-1 EN 61000-6-2 EMC - Industrial level; EN 61000-6-3 EMC - Commercial level

Specifications are subject to changes without prior notice.
All values measured in specific conditions.



BEA SA | LIEGE Science Park | ALLÉE DES NOISETIERS 5 - 4031 ANGLEUR [BELGIUM] | T +32 4 361 65 65 | F +32 4 361 28 58 | INFO@BEA.BE | WWW.BEA-SENSORS.COM



BEA hereby declares that the LZR®-U903/-U904 is in conformity with the basic requirements and the other relevant provisions of the directives 2014/35/EU, 2011/65/EU and 2014/30/EU.



The complete declaration of conformity is available on our website: WWW.BEA-SENSORS.COM

EC countries: according to the directive 2012/19/EU for Waste Electrical and Electronic Equipment (WEEE)