

# ORASCAN P

Opening & Safety sensor for automatic sliding doors (according to EN 16005 and DIN 18650 including emergency exits).

User's Guide for software version 0100 and higher (refer to tracking label on product)

## INTENDED USE

The ORASCAN is an opening and safety sensor for sliding doors using dual technology: Artek radar technology for smart opening and time-of-flight laser for a complete 180° safety coverage of the door threshold, including side screen safety. A module must be installed on both sides of the door.

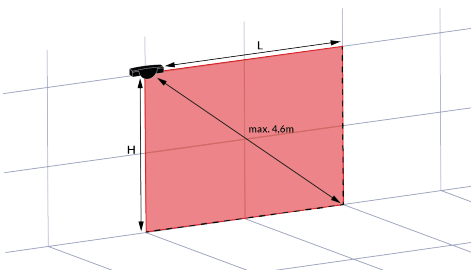
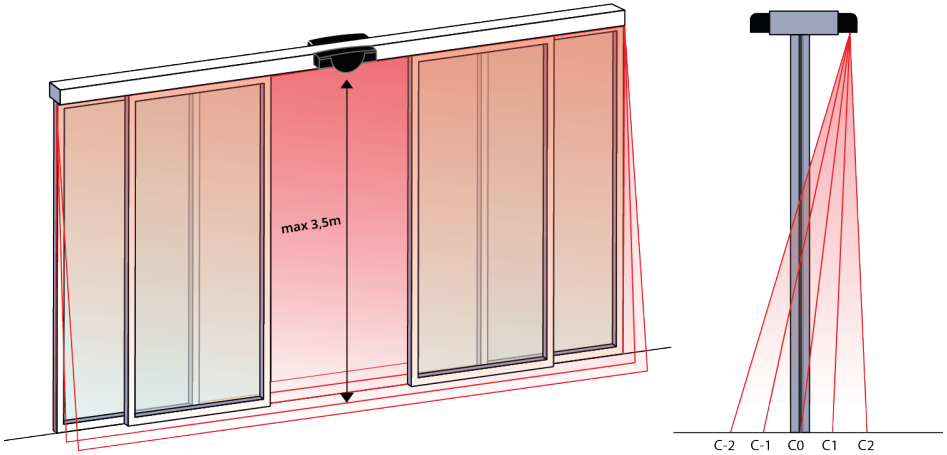







H	L
2m	max. 4,0m
2,5m	max. 3,8m
3m	max. 3,5m
3,5m	max. 3,0m



- The sensor cannot be used for purposes other than its intended use.
- The manufacturer of the door system incorporating the sensor is responsible for compliance of the system to applicable national and international regulations and safety standards.
- The installer must read, understand and follow the instructions given in this manual. Improper installation can result in improper sensor operation.
- The manufacturer of the sensor cannot be held responsible for injury or damage resulting from incorrect use, installation or inappropriate adjustment of the sensor.

# 1. TIPS





## INSTALLATION TIPS

			
Avoid vibrations.	Do not cover the laser window.	Avoid moving objects and light sources in the detection field.	Avoid presence of smoke in the detection field
			
Avoid condensation.	Avoid exposure to sudden and extreme temperature changes.	Keep the sensor permanently powered in environment where the temperature can descend below -10°.	

## SAFETY TIPS

			
The door control unit and the door cover profile must be correctly earthed.	Only trained and qualified personnel may install and setup the sensor.	Always test the good functioning of the installation before leaving the premises.	

## MAINTENANCE TIPS

			
Clean the laser window with compressed air. If needed, wipe only with a soft, clean and damp microfibre cloth.	Do not use dry or dirty towels or aggressive products to clean the laser window.	Avoid direct exposure to high pressure cleaning.	The warranty is invalid if unauthorized repairs are made or attempted by unauthorized personnel.

## 2. DESCRIPTION

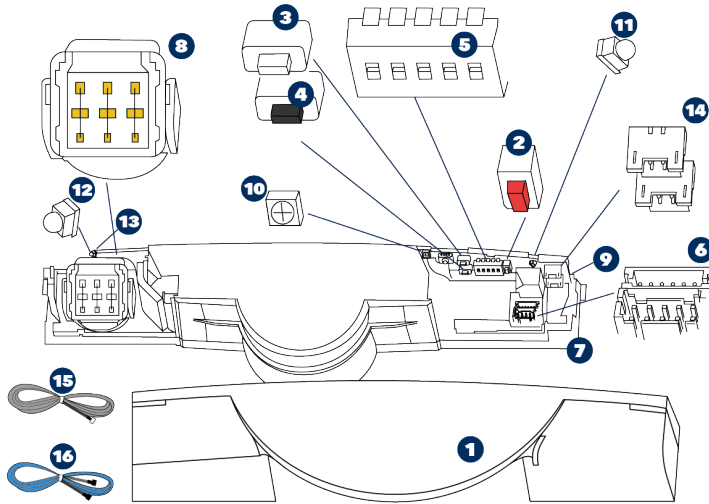

- |          |                       |           |                                      |           |                        |
|----------|-----------------------|-----------|--------------------------------------|-----------|------------------------|
| <b>1</b> | Cover                 | <b>7</b>  | Mounting base                        | <b>13</b> | Bluetooth® LED (white) |
| <b>2</b> | Red push button       | <b>8</b>  | Radar antenna                        | <b>14</b> | BLUESPIN connectors    |
| <b>3</b> | White push button (+) | <b>9</b>  | BLUESPIN LED (white)                 | <b>15</b> | Power cable            |
| <b>4</b> | Black push button (-) | <b>10</b> | Main LED (multi color)               | <b>16</b> | BLUESPIN cable         |
| <b>5</b> | DIP-switch            | <b>11</b> | Sidescreen safety : right side (red) |           |                        |
| <b>6</b> | Connectors            | <b>12</b> | Sidescreen safety : left side (red)  |           |                        |

### LED SIGNALS

- |                                     |                        |                                       |                      |
|-------------------------------------|------------------------|---------------------------------------|----------------------|
| <span style="color: red;">●</span>  | Safety                 | <span style="color: red;">●</span>    | LED blinks           |
| <span style="color: blue;">●</span> | Opening                | <span style="color: red;">●</span>    | LED blinks slowly    |
| ○                                   | Bluetooth® or BLUESPIN | <span style="color: red;">●</span>    | LED blinks quickly   |
| ●                                   | LED is off             | <span style="color: orange;">●</span> | LED blinks x times   |
|                                     |                        | <span style="color: green;">●</span>  | LED blinks red-green |

### 3. MOUNTING ON DOOR



#### NOTE

The ORASCAN sensor must be paired with another ORASCAN using the supplied BLUESPIN cable.

ORASCANS can be connected to a door controller using previously installed IXIO cables. Please refer to the application note.

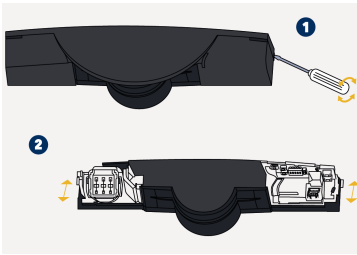

1. Remove the cover: Insert a screwdriver on the left or the right notch of the sensor and twist it.
2. Slide and remove the base off the sensor module.

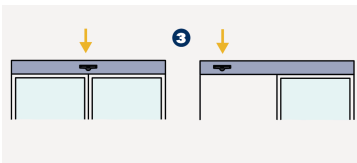

3. Identify the position of the sensor on the door. On a double-leaf sliding door, position the sensor in the middle of the door. On a single-leaf sliding door, position the sensor closest to the main closing edge.

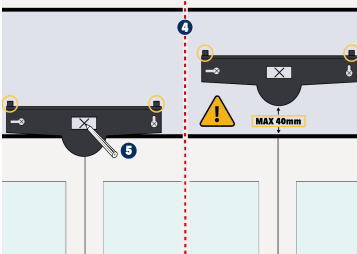

4. Place the base on the door frame. **Put the sensor as low as possible**, ensuring it stays within 40mm from the bottom of the door controller. The positioning aids prevent you from fixing it too high.
5. Using a pencil, mark the position of the holes to drill into the operator cover or the wall. You can also use the inner surface of the base to fasten the screws.

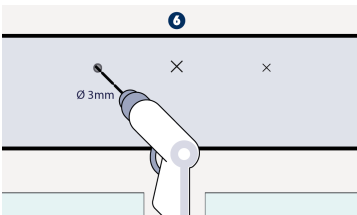

6. Remove the base and pre-drill the holes where marked.

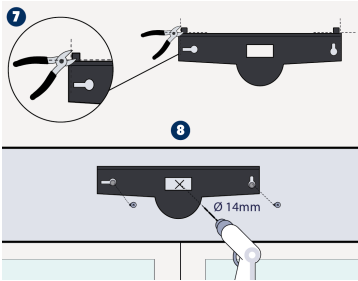

7. Remove the positioning aids from the base.
8. Fasten the 2 screws using a Torx screwdriver. The base needs to be fixed firmly and securely! Drill through the 2 bases and the door using a 14mm bit in order to pass the POWER and the BLUESPIN cables. Soften the edges using a sheet of sandpaper.

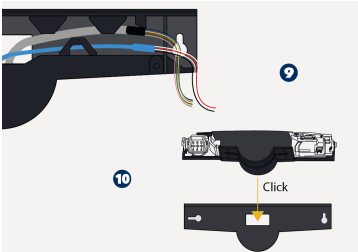

9. Take all cables and pass them in the channel. Position the cable in the notch of the base and make sure it is firmly fixed.
10. Place and slide the sensor module on the base.

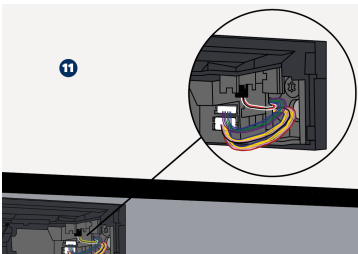

11. Connect the plugs to the connectors. The sensor connected to the door controller will be the main module.

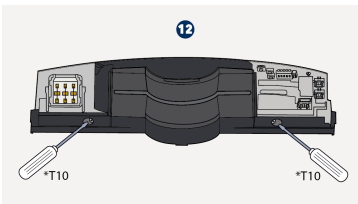

12. Fasten the lock firmly and make sure the sensor is mounted securely.

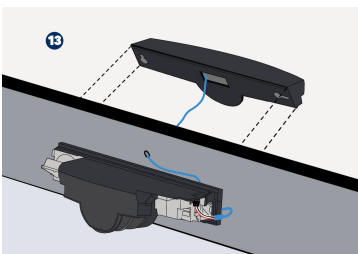

13. Install the second module following the same steps and connect it to the BLUESPIN cable.

# 4. WIRING

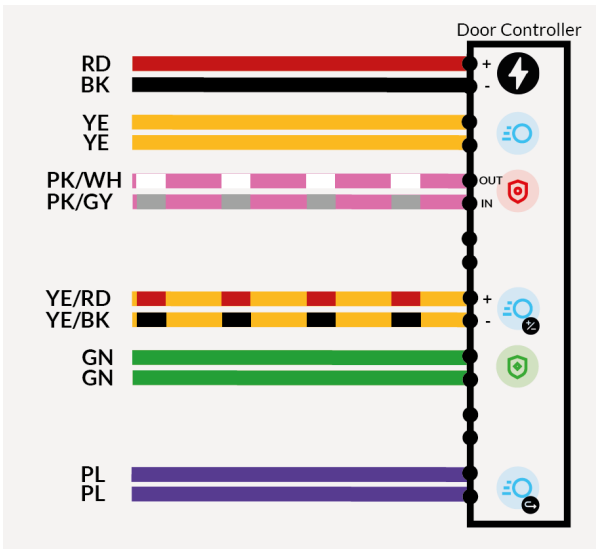
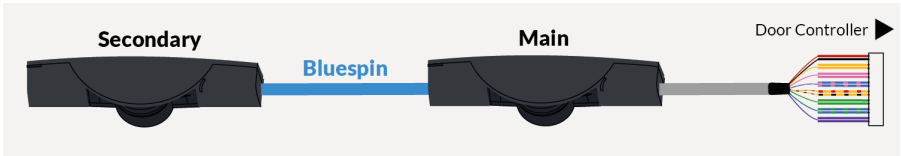
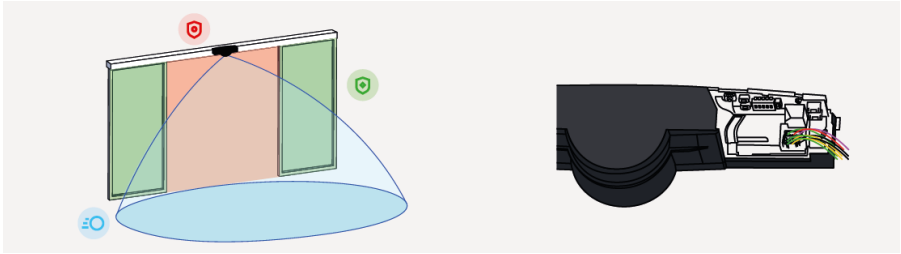

Power supply: 12-30VDC

Opening: Main Orascan

Safety: Door threshold

Opening: Current source





Safety: Door sidescreen

Opening: Secondary Orascan



## CAUTION

External electrical sources must ensure double insulation from primary voltages.

	<p><u>1 Electronic relays galvanic isolation (polarity free)</u></p> <ul style="list-style-type: none"> <li>• Max. contact current : 100 mA</li> <li>• Max. contact voltage: 42V DC / 30V AC</li> <li>• in switching mode: NO/NC</li> <li>• in frequency mode: pulsed signal in no detection (f = 100 Hz)</li> <li>• in inverted frequency mode: pulsed signal in detection (f = 2.5 Hz)</li> </ul>	
	<p><u>1 Galvanically isolated current source</u></p> <ul style="list-style-type: none"> <li>• No detection: current source ON</li> <li>• Open circuit voltage: 6.5 V</li> <li>• Output voltage available at 10 mA: 3 V min.</li> <li>• Typical load: up to 3 optocouplers in series</li> <li>• Detection: current source OFF</li> <li>• Open circuit residual voltage &lt; 500 mV</li> </ul>	
 	<p><u>2 safety pulse inputs :</u></p> <ul style="list-style-type: none"> <li>• Pulse polarity: positive or negative (adjustable)</li> <li>• Impedance: <ul style="list-style-type: none"> <li>- Positive pulse: 2 K to ground</li> <li>- Negative pulse: 470 R to + sensor power supply</li> </ul> </li> <li>• Pulse voltage: 6 V to 30 V</li> <li>• Pulse duration: 4 µs to 500 µs</li> <li>• Duty cycle: max. 50%</li> </ul>	<p><u>2 safety pulse outputs:</u></p> <ul style="list-style-type: none"> <li>• Pulse polarity: negative</li> <li>• Level: <ul style="list-style-type: none"> <li>- Standby: Pulse from V to ground</li> <li>- Detection: V Supply</li> </ul> </li> <li>• Topology: open-collector with 4.7 K to 3.3 V</li> <li>• Max. sink current: 25 mA with external 1 K to 24 V</li> </ul>
	<p><u>1 Electronic relay galvanic isolation (polarity free)</u></p> <ul style="list-style-type: none"> <li>• Max. contact current : 800 mA</li> <li>• Max. contact voltage: 42V DC / 30V AC</li> </ul>	



## 5. DIP SWITCH SETTINGS

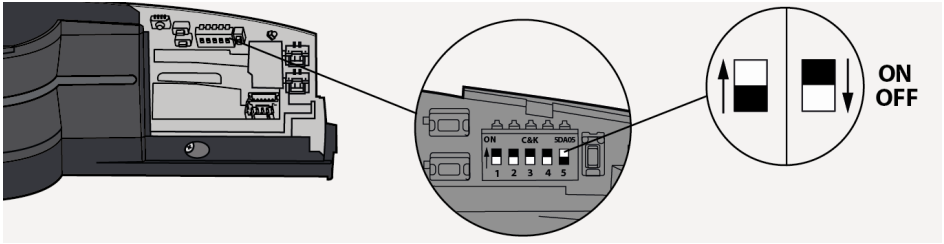

DIP 1 : MOUNTING SIDE	
ON :	INSIDE
OFF :	OUTSIDE*

DIP 2 : ESCAPE ROUTE	
ON :	RADAR OUTPUT > FREQUENCY + CURRENT
OFF :	RADAR OUTPUT > NO*
Switch to ON to ESCAPE ROUTE to use the radar output in frequency or current source mode for an emergency exit application.	

DIP 3 : SIDESCREEN SAFETY	
ON :	SIDESCREEN SAFETY ON 2 CURTAINS
OFF :	NO SIDESCREEN SAFETY*
Switch to ON to activate both laser curtains in the sidescreen field.	

DIP 4 : TEACH-IN MODE	
ON :	MANUAL TEACH-IN
OFF :	AUTOMATIC TEACH-IN*
Switch to MANUAL to position the laser curtains and to define the safety area limits manually.	

DIP 5 : BLUESPIN CHAIN END (ON*/ OFF)	
Switch OFF if two BLUESPIN cables are connected on this ORASCAN module.	

\*Factory Values

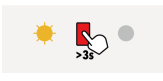

After changing a DIP- switch, the main LED blinks orange. A long push on the red push button confirms the settings.

## SERVICE MODE

The service mode deactivates the safety detection during 15 minutes and can be useful during an installation, a mechanical teach-in of the door or maintenance work.

To enter the service mode, push on the red push button for > 3 seconds. When the sensor is in service mode, all safety-related LEDs are OFF

To exit the service mode, push the red push button again for > 3 seconds.

The service mode is deactivated automatically when launching a teach-in.

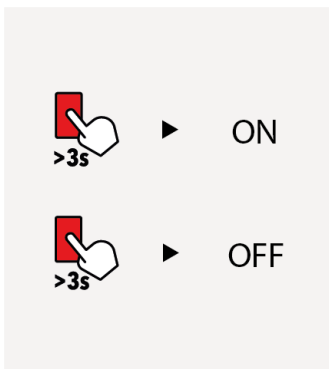

## 6. RADAR OPENING IMPULSE FIELD

### ANGLE

Tilt the antenna to position the radar opening field

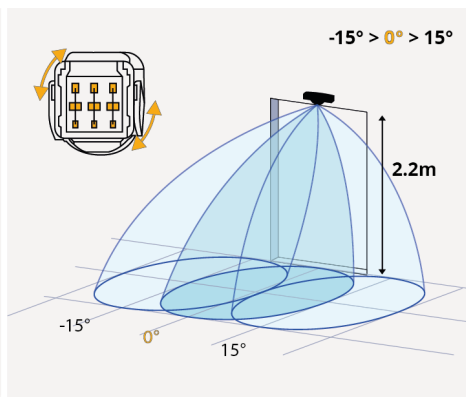
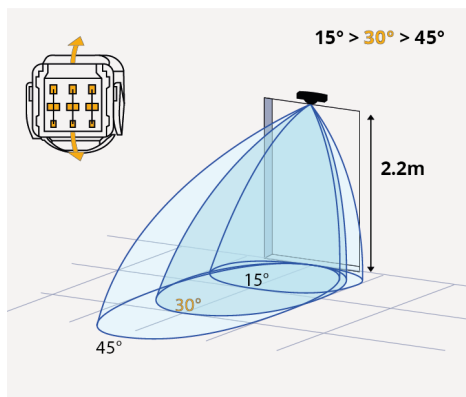

### FIELD SIZE

Use the white button to increase the field size and the black button to decrease the field size.

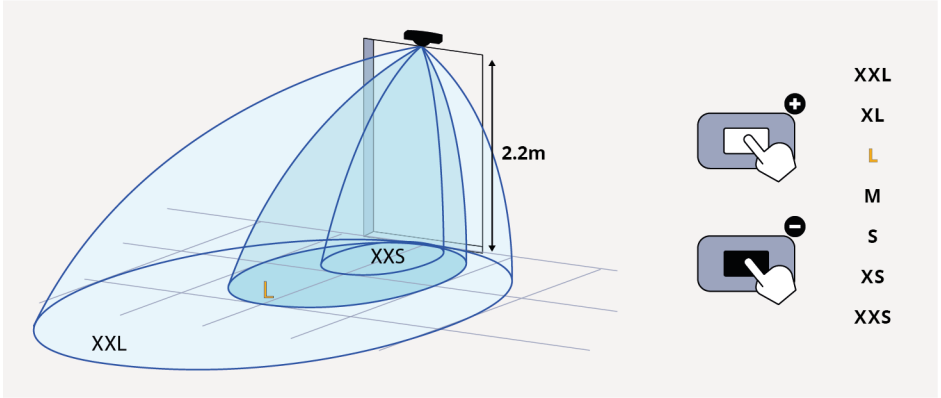

### SHAPE

Wide mode: press the black button 3s, when the LED turns purple, press the white one.

Narrow mode: press the black button 3s, when the LED turns purple, press the black one.

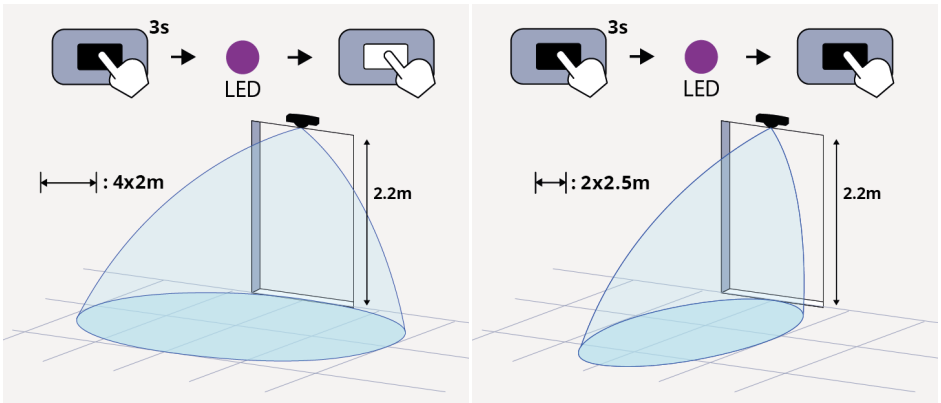

## 7. TEACH-IN



### NOTE

- Make sure the door operates in summer mode (full opening) during the teach-in.
- Make sure you and anyone else are outside the detection field during the teach-in process. If people are inside the detection field, the sensor may not work as expected.
- If the moving panels have no metallic frame, activate the "fog & full glass filter" with the mobile app (safety settings tab) and cover their edges from top to bottom with a large paper tape (at least 3cm wide). This strip can be removed once the teach-in is finished

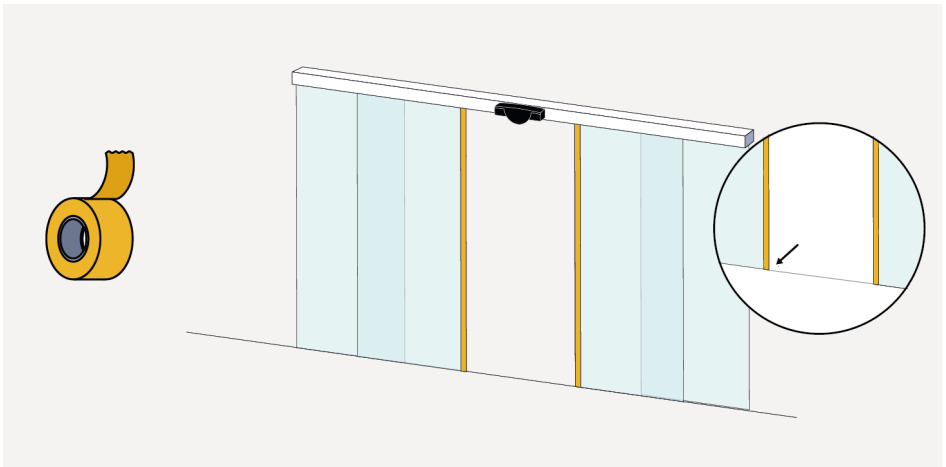

### AUTOMATIC TEACH IN

1. Make sure the DIP switch 4 is OFF and the door is in automatic mode. If you turn it ON, refer to the manual teach In.
2. After changing a DIP-switch, the orange LED blinks. A long push on the red push button confirms the settings.

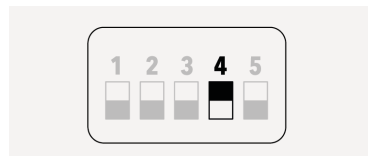

- All you need to do is press the red square push button and wait outside of the laser curtains. LED starts flashing red-green. The door opens automatically. You can hear the motor positioning the curtains correctly. The sensor learns its environment, defines the safety areas and then does a few opening and closing cycles.



#### NOTE

The curtains are positioned by a stepper motor. Motor noise is normal.

- Once the door is completely closed and all the LEDs are OFF, the teach-in is completed. Check the correct positioning of the safety fields by placing an object in the detection field. If needed, adapt them manually.

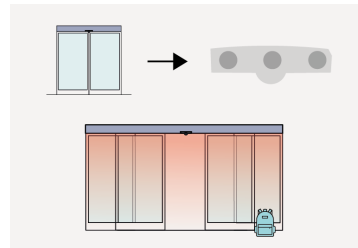

### MANUAL TEACH IN

You can adjust the laser curtains and set up the detection zone manually.

- Make sure the DIP switch 4 is ON to activate the manuel teach-In. If you turn it OFF, refer to automatic teach In.
- After changing a DIP-switch, the orange LED blinks. A long push on the red push button confirms the settings.
- Make a double short push on the red button. All LEDs start blinking red. The door opens automatically.

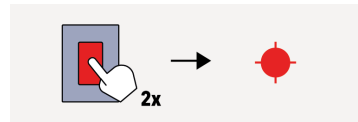
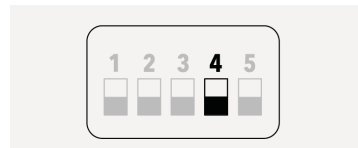

#### NOTE

Only the central curtain is active. Use the Spotfinder to locate it. All curtains of the second ORASCAN are OFF.

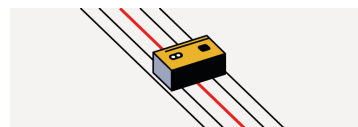

- Press the black square push button to move the laser curtains towards the back of the door.  
Press the white square push button to move the laser curtains towards the front of the door.

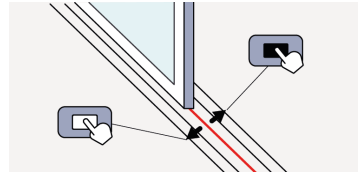

- Press the red square push button. LED starts blinking red-green. The door opens automatically.



- Make sure you are out of the detection field and observe the following LED signals. The left and right red LEDs on the sensor indicate the position where a hand movement is requested. The main central LED indicates when to pass your hand through the field (green color) or wait (red color). When central LED is green, make an up and down movement with your arm at position « A ». Your arm should be at the left end of the main closing edge area to limit the detection zone. The central LED will blink red while calculating the width. Repeat the process at points B, C and D (B & D are only requested if the sidescreen safety is activated).

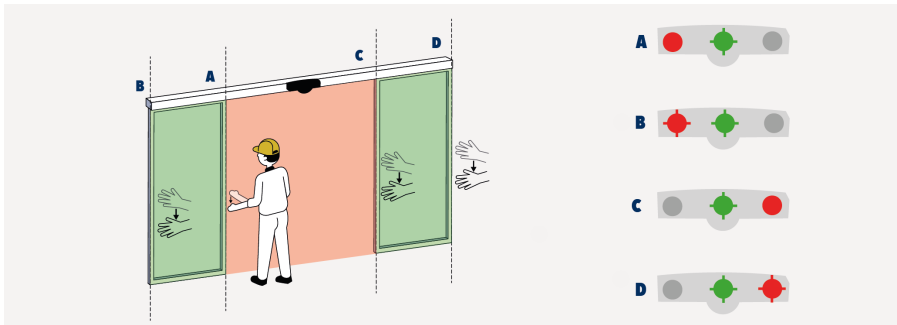

- Once the door is completely closed and all the LEDs are OFF, the teach-in is completed. Check the correct positioning of the safety fields by placing an object in the detection field. If needed, adapt them manually.

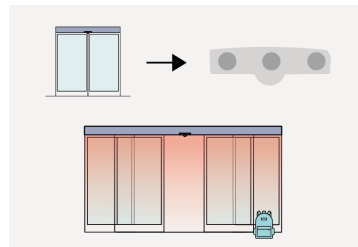

## 8. MOBILE APP (OPTIONAL)

Scan the QR code or open the following link to download the mobile application.

<https://l.ead.me/belDmx>



At power ON or after a power cycle, the Bluetooth® is activated for 30 min and the Bluetooth® LED is flashing white.



Open the Orascan mobile app and connect to the sensor. The password is indicated on the Bluetooth® notice contained in the packaging. When the smartphone is pairing with the sensor, the Bluetooth® LED is flashing quickly.









Once paired, the Bluetooth® LED is ON.



The Bluetooth® word mark and logos are registered trademarks owned by Bluetooth SIG, Inc. and any use of such marks by BEA sa is underlicense. Other trademarks and trade names are those of their respective owners

## 9. TROUBLESHOOTING

LED	Status	Explanation / Solution
	The ORANGE LED is on permanently	<b>The sensor encounters a memory problem.</b> Replace sensor
	The ORANGE LED blinks quickly	<b>DIP-switch setting awaiting confirmation.</b> Confirm the DIP-switch setting: long push on the red push button.
	The ORANGE LED blinks 1x	<b>The sensor signals an internal fault.</b> Power the device OFF and ON. LED flashes again, replace sensor.
	The ORANGE LED blinks 2x	<b>Power supply is out of limit.</b>  1. Check power supply. 2. Reduce the cable length or change cable.  <b>Internal temperature is too high.</b> Protect the sensor from any heat source (sun, hot air...)
	The ORANGE LED blinks 3 x quickly	<b>Internal communication error.</b> Check wiring of the radar antenna.

LED	Status	Explanation / Solution
	The ORANGE LED blinks 3x	<p><b>Communication error between modules</b></p> <ol style="list-style-type: none"> <li>1. Check that the DIP1 of both Orascan are set to different mounting sides of the door.</li> <li>2. Check wiring between the sensors on the BLUESPIN bus.</li> <li>3. Press the red push button during 3 seconds if a sensor (e.g Eagle Artek) has been permanently removed from the BLUESPIN bus (note: not applicable to both modules of an ORASCAN kit)</li> </ol>
	The ORANGE LED blinks 4x	<p><b>The sensor does not see its background.</b> Switch background setting to off via the mobile app (attention: no conformity to DIN 18650 or EN 16005).</p> <p><b>Something close to the sensor is masking part of the detection field.</b></p> <ol style="list-style-type: none"> <li>1. Make sure the laser window is not scratched. If it is, replace sensor.</li> <li>2. Remove all masking elements (insects, spider web).</li> <li>3. Verify if the laser window is dirty and clean it with compressed air. Then wipe it carefully with a damp and clean microfibre cloth if necessary.</li> <li>4. Switch antimasking setting to off via the mobile app (attention: no conformity to DIN 18650 or EN 16005).</li> </ol> <div style="background-color: #f4a460; padding: 10px; margin-top: 10px;">  <p><b>CAUTION</b> The surface of the laser window is delicate.</p> </div>
	The ORANGE LED blinks 5x	<p><b>Teach-in error.</b></p> <ol style="list-style-type: none"> <li>1. Check whether all teach-in requirements are fulfilled (see Teach-in) and launch a new teach-in.</li> <li>2. Turn ON DIP 4 and launch a manual teach-in.</li> </ol>
	The ORANGE LED blinks 6x	<p><b>Teach-in warning.</b> Positioning of the laser curtains is not optimal. If this is acceptable, validate the teach-in by a long push on the red button.</p>
	The ORANGE LED blinks 7x	<p><b>The internal test of the radar is disturbed.</b></p> <ol style="list-style-type: none"> <li>1. Launch a radar calibration (cover on) with the mobile app.</li> <li>2. If the orange LED flashes again, increase the size of the opening field or raise the antenna so that Orascan detects at least 1.5m in front of the door. Restart from step 1.</li> <li>3. If the LED still flashes orange or you can't set up a sufficiently large opening field, replace sensor.</li> </ol>
	Red LED blinks	<p><b>The sensor has noticed some environment changes and has launched a new reference picture.</b></p> <ol style="list-style-type: none"> <li>1. Clear field and wait until the door closes.</li> <li>2. If the door does not close, abort it by pressing the red button.</li> <li>3. Launch a new teach-in.</li> </ol>



LED	Status	Explanation / Solution
	Red LED lights up sporadically or permanently.	<b>The sensor vibrates.</b> <ol style="list-style-type: none"> <li>1. Check if the sensor is fastened firmly.</li> <li>2. Check position of cable and cover.</li> </ol>
		<b>The sensor sees the door or door frame.</b> Launch a new teach-in.
		<b>Unwanted detections (due to environment or external conditions).</b> <ol style="list-style-type: none"> <li>1. Clear field</li> <li>2. Verify if the laser window is dirty and clean it with compressed air. Then wipe it carefully with a damp and clean microfibre cloth if necessary (attention: the surface of the laser window is delicate).</li> <li>3. Launch a new teach-in</li> <li>4. Increase the object size filter</li> </ol>
	Blue LED lights up sporadically	<b>The sensor is disturbed by rain and/or leaves.</b> Increase radar-immunity filter.
		<b>Ghosting created by door movement.</b> <ol style="list-style-type: none"> <li>1. Change radar field angle.</li> <li>2. Activate the door filter via the mobile app.</li> </ol>
		<b>The sensor vibrates.</b> <ol style="list-style-type: none"> <li>1. Check if the sensor and door cover are fastened firmly.</li> <li>2. Check position of cable and cover.</li> </ol>
		<b>The sensor sees other moving objects</b> <ol style="list-style-type: none"> <li>1. Remove the objects if possible.</li> <li>2. Change radar field size or angle.</li> </ol>
	LED stays off.	<b>The sensor is not powered.</b> <ol style="list-style-type: none"> <li>1. Check wiring</li> <li>2. Replace cable</li> <li>3. Replace sensor</li> </ol>
		<b>Test error.</b> <ol style="list-style-type: none"> <li>1. Check voltage of the test input(s)</li> <li>2. Press the push button during at least 3 seconds to exit the service mode.</li> </ol>



## 10. TECHNICAL SPECIFICATIONS

<b>Supply voltage</b>	12 – 30V DC +/-10% External electrical sources must ensure double insulation from primary voltages.
<b>Max Power consumption</b>	<5W
<b>Mounting Height</b>	2m to 3,5m
<b>Temperature range</b>	-25°C to +55°C; 0-95% relative humidity, non condensing
<b>Vibrations</b>	<2G
<b>Degree of protection</b>	IP54 (IEC/EN 60529)
<b>Material</b>	PC/ASA
<b>Weighted emission sound pressure level</b>	< 70 dB (A)

<b>Detection mode</b>	Motion	Presence
<b>Technology</b>	Microwave doppler radar <ul style="list-style-type: none"> <li>• Transmitter frequency: 24.150 GHz</li> <li>• Transmitter radiated power: &lt; 20dBm EIRP</li> <li>• Transmitter power density: &lt; 5 mW/cm<sup>2</sup></li> <li>• Min. Detection speed: 5 cm/s</li> </ul>	LASER scanner, time-of-flight measurement <ul style="list-style-type: none"> <li>• Max. detection range: 4.6m (diagonal) with reflectivity ≥ 2%</li> <li>• Field of view: 180°</li> <li>• Angular resolution: 0.72°</li> <li>• Typ. Min. object size: 5cm @ 4m</li> <li>• Optical characteristics (IEC/EN 60825-1): IR LASER: wavelength 905nm; output power &lt; 0.1mW; Class 1</li> <li>• Response time: typ. &lt; 180ms (max 680ms)</li> <li>• Tilt angle: 0° to -7°</li> <li>• Test body: 700 mm × 300 mm × 200 mm (testbody CA according to EN 16005 &amp; DIN 18650)</li> </ul>
<b>Safety standards</b>	EN ISO 13849-1 PL «d» CAT. 2 EN 16005 (emergency exits) DIN 18650-1 (emergency exits) AutSchR (only applicable for radar output in frequency mode and current source output)	EN ISO 13849-1 PL «d» CAT. 2 EN 16005 (protective devices) DIN 18650-1 (protective devices) EN 12978
<b>Bluetooth®</b>	Operating bandwidth: 2402 MHz – 2480 MHz Maximum transmitted power: 12 dBm	

Specifications are subject to change without prior notice. All values measured in conditions and with a temperature of 25°C

## Conformity

<p>BEA hereby declares that this product is in compliance with European legislation 2006/42/EC (Machinery), 2014/53/EU (RED) and 2011/65/EU (RoHS).</p> <p>The complete declaration of conformity is available on our website.</p>	
<p>EC-type examination certificate from TÜV NORD CERT: 44 205 13089646</p>	
<p>This product should be disposed of separately from unsorted municipal waste.</p>	



WWW.BEASENSORS.COM

BEA SA | LIEGE Science Park | ALLÉE DES NOISETIERS 5 - 4031 ANGLEUR [BELGIUM] | T +32 4 361 65 65 | F +32 4 361 28 58 | info-eu@beasensors.com | WWW.BEASENSORS.COM



A **Halma** company

Manufactured by: BEA SA - LIEGE Science Park - Allée des Noisetiers 5 - 4031 Angleur - Belgium - T +32 4 3616565 - F +32 4 3612858 - info-eu@beasensors.com - www.beasensors.com

PLEASE KEEP FOR FURTHER USE - DESIGNED FOR COLOUR PRINTING