

SPARROW

UNIDIRECTIONAL OPENING SENSOR FOR AUTOMATIC INDUSTRIAL DOORS*

DESCRIPTION

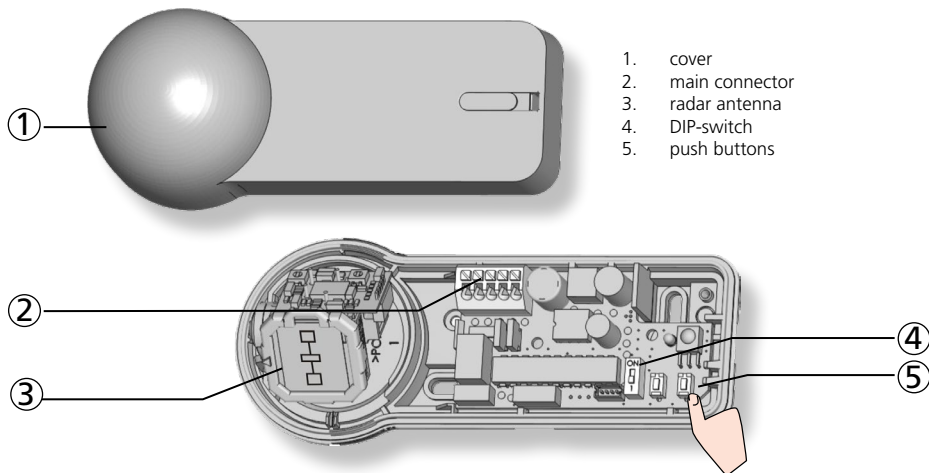

TECHNICAL SPECIFICATIONS

Technology:	microwave
Transmitted frequency:	24.150 GHz
Transmitted radiated power:	< 20 dBm EIRP
Transmitted power density:	< 5 mW/cm ²
Detection mode:	motion
Min. detection speed:	5 cm/s (measured in the sensor axis)
Supply voltage:	12V to 24V AC \pm 10%; 12V to 24V DC +30% / -10%
Mains frequency:	50 to 60 Hz
Max power consumption:	< 2 W
Output:	relay (free of potential change-over contact)
Max. contact voltage:	42V AC - 60V DC
Max. contact current:	1A (resistive)
Max. switching power:	30W (DC) / 60VA (AC)
Mounting height:	from 2 m to 6 m
Degree of protection:	IP64
Temperature range:	from -30 °C to + 60 °C
Dimensions:	140 mm (L) x 55 mm (H) x 57 mm (W)
Tilt angles:	0° to 90° vertical; -120° to +120° lateral
Material:	ABS
Weight:	165 g
Cable length:	10 m
Conformity:	RED 2014/53/EU ; 2011/65/EU

Specifications are subject to changes without prior notice.

* Other use of the device is outside the permitted purpose and can not be guaranteed by the manufacturer.

1 OPENING & CLOSING

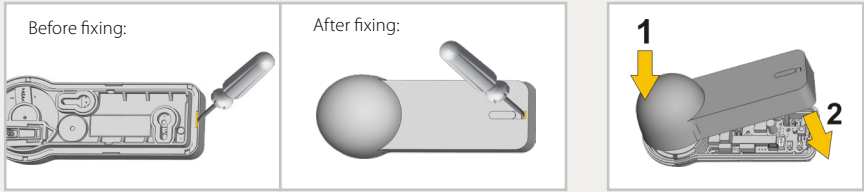

2 MOUNTING & WIRING

TIPS

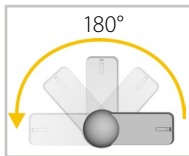

The sensor can be installed in various positions. But always verify the antenna position.

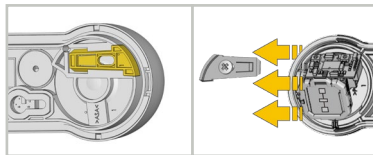

The sensor can easily replace an EAGLE thanks to the retrofit clip.

1. Remove the clip.
2. Fix it with the existing screw.
3. Slide the sensor on the clip.

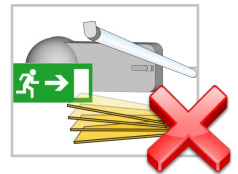

Avoid proximity to neon lamps or moving objects. Do not cover the sensor.

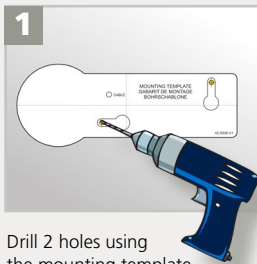

Drill 2 holes using the mounting template.

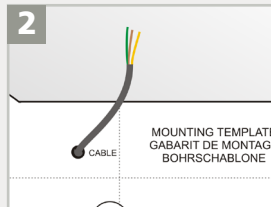

Drill a hole for the cable and pull tinned through towards the sensor

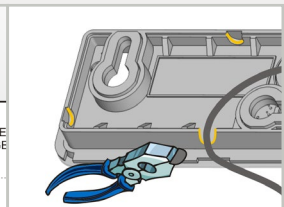

... or use one of the cable conduits. Avoid using the one at the top to ensure waterproofness.

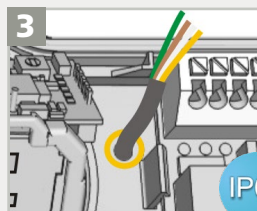

Pass the cable through the opening.

IP64

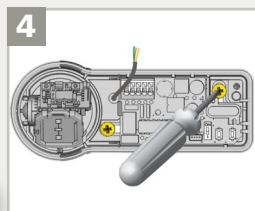

Fix the sensor firmly to avoid vibrations.

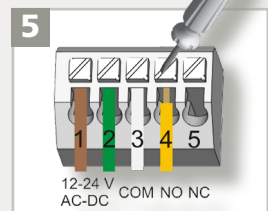

Connect the wires accordingly.

12-24 V
AC-DC

COM NO NC

3 DETECTION FIELD

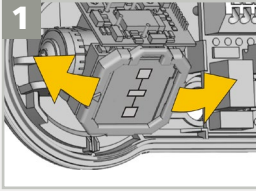

Adjust the lateral antenna angle.

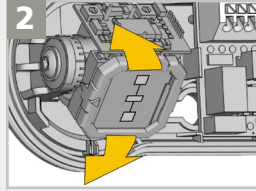

Adjust the vertical antenna angle.

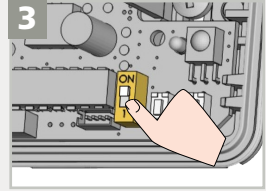

If mounting height > 4.5 m, activate BOOST function by DIP-switch.

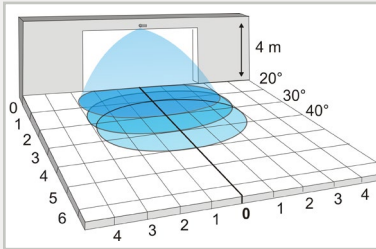

Mounting height: 4 m
Boost function: OFF
Factory values

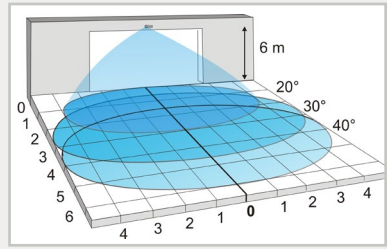

Mounting height: 6 m
Boost function: ON
Factory values

4 SETTINGS (by remote control or push buttons)



FIELD SIZE		XXS	XS	S	<	<	>	>	L	XL	XXL
IMMUNITY FILTER			normal	high							
DETECTION MODE			bi	uni	uni AWAY	<small>bi = two-way detection uni = one-way detection towards sensor uni AWAY = one-way detection away from sensor</small>					
OUTPUT CONFIGURATION			A	P	<small>A = active output (NO-contact) P = passive output (NC-contact)</small>						

RESETTING TO FACTORY VALUES:

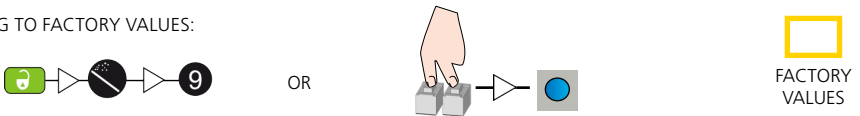

FIELD SIZE

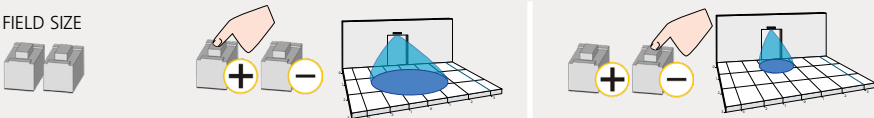

ACCESS CODE

The access code (1 to 4 digits) is recommended to set sensors installed close to each other.

If you forget the access code, **cut and restore the power supply**.

During 1 minute, you can access the sensor without introducing any access code.

SAVING OR CHANGING AN ACCESS CODE:



DELETING AN ACCESS CODE:



TROUBLESHOOTING

	The door will not open. The LED is OFF.	The sensor power is off.	1 Check the wiring and the power supply.
	The door will not close. The LED is OFF.	Improper output configuration on the sensor. Improper wiring	1 Check the output configuration setting on each sensor connected to the door operator. Verify wiring
	The door opens and closes constantly.	The sensor is disturbed by the door motion or vibrations caused by the door motion.	1 Make sure the sensor is fixed properly. 2 Make sure the detection mode is unidirectional. 3 Increase the tilt angle. 4 Reduce the field size. 5 Increase the immunity filter.
	It rains and the sensor detects for no apparent reason.	The sensor detects the motion of the rain drops.	1 Make sure the detection mode is unidirectional. 2 Increase the immunity filter. 3 Install the ORA (rain accessory).
	The sensor detects objects outside its detection field.	Metallic environment	1 Increase the immunity filter. 2 Decrease the field size.
	The LED flashes quickly after unlocking.	The sensor needs an access code to unlock.	1 Enter an access code. 2 Cut and restore the power supply to access the sensor. Change or delete the access code.
	The sensor does not respond to the remote control.	Batteries in the remote control are weak or installed improperly. Remote control badly pointed.	1 Check and change the batteries if necessary. 1 Point the remote control towards the sensor.



BEA hereby declares that the SPARROW is in conformity with the basic requirements and the other relevant provisions of the standards 2014/53/EU and 2011/65/EU.

The complete declaration of conformity is available on our website.

This product should be disposed of separately from unsorted municipal waste

