



WHAT WE DO

SENSING SOLUTIONS

for automatic applications

SUMMARY



4

SOLUTIONS
*A broad spectrum
of solutions*



6

APPLICATIONS
*The right solution
for every application*

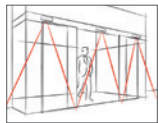

8

FUNCTIONS
What do you need?

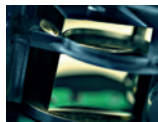

10

TECHNOLOGY
Behind the scenes



12

PRODUCTS
Ready to detect?



16

SERVICE
An eye for detail

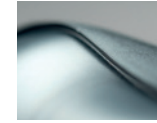

18

DESIGN
In all discretion



20

INSTALLATION
Ready, Set, Go!



22

INNOVATION
Tomorrow is already here



24

COLLABORATION
Close relationship & Passion



26

CONTACT
Get in touch & Stay tuned

A BROAD SPECTRUM OF SOLUTIONS

BEA designs and manufactures sensing solutions for automatic systems in various fields of activity.

We help facilitate people's access to public buildings, optimize traffic flow in warehouses, protect vehicles in parking lots, count visitors in shopping malls, improve platform safety in stations, secure artwork in museums and much more...



SECURITY & ACCESS SOLUTIONS



VEHICLE SENSING SOLUTIONS



INDUSTRIAL AUTOMATION SOLUTIONS



PEOPLE COUNTING SOLUTIONS



PEDESTRIAN SENSING SOLUTIONS



PUBLIC TRANSPORTATION SOLUTIONS

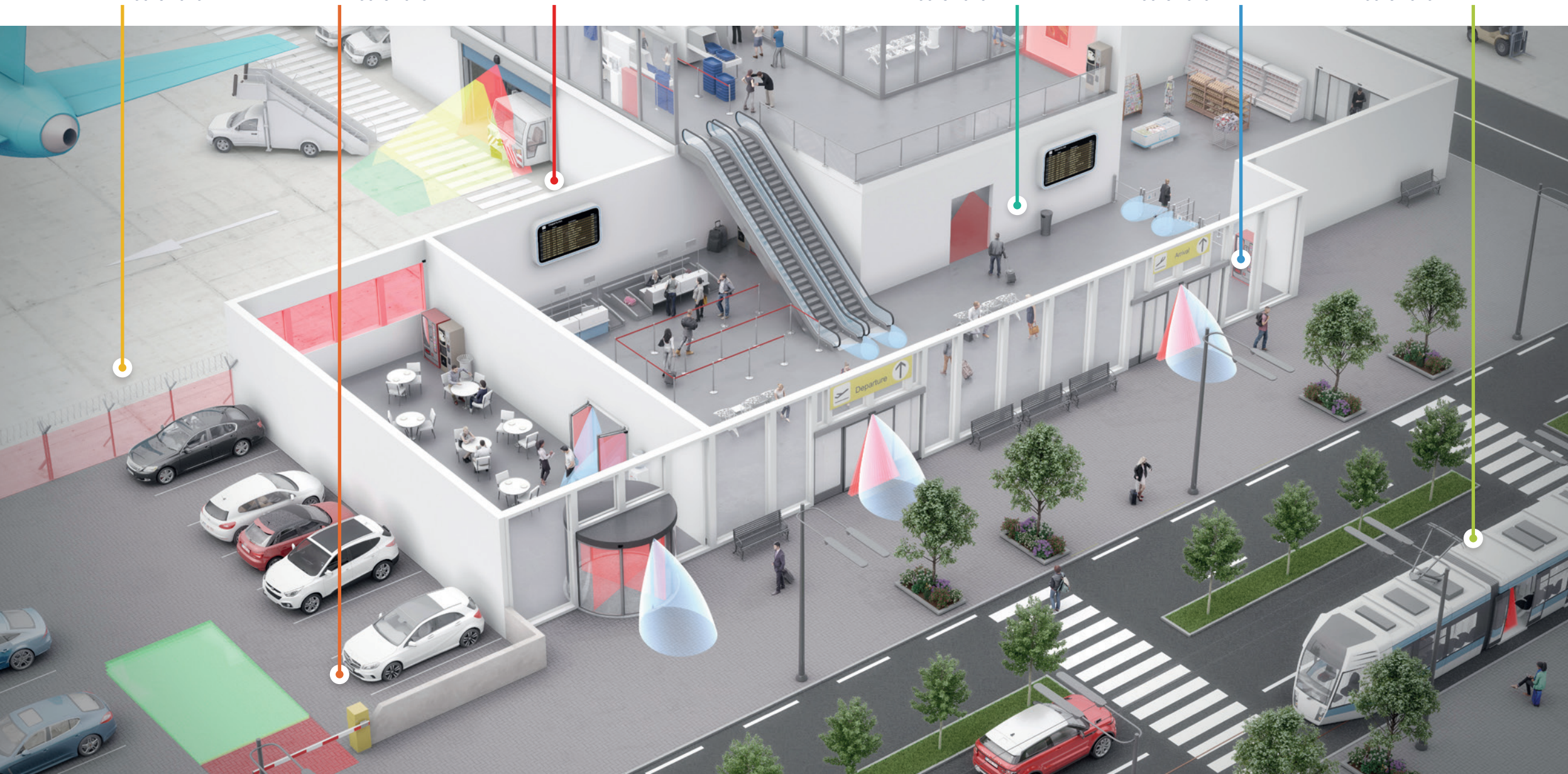



THE RIGHT SOLUTION FOR EVERY APPLICATION

Our goal is to develop sensing solutions that make everyday life easier for you, your customers and all users across a wide variety of applications.

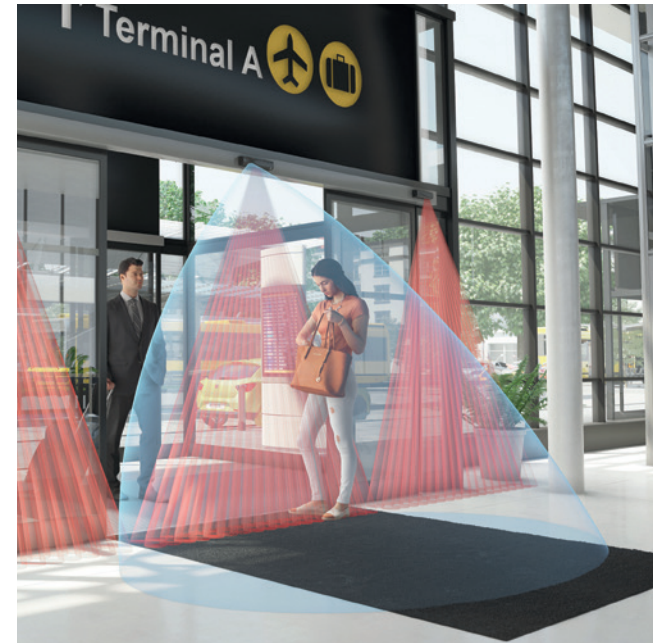

1



2



3

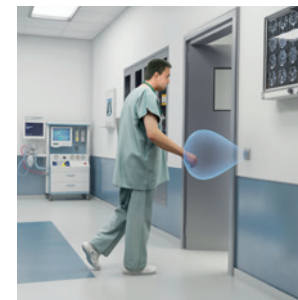

4



5

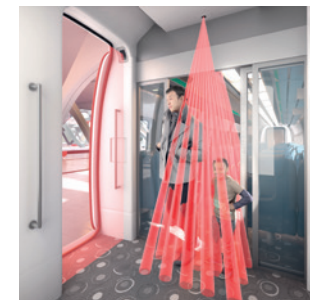

6

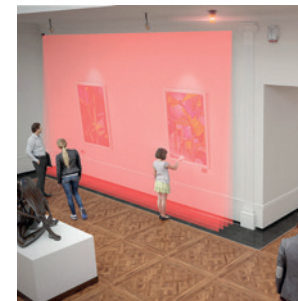

7



8

- 1. Sliding doors
- 2. Barriers
- 3. Swing doors
- 4. Knowing act devices
- 5. Industrial doors
- 6. Train doors
- 7. Artwork protection
- 8. People counting

What is your application ?

WHAT

DO YOU NEED ?

OPENING

We open doors and activate various other automated systems

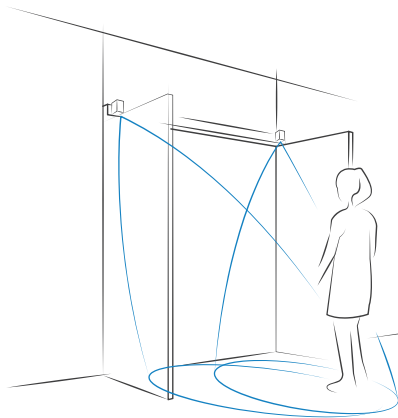

SAFETY

We protect people in conformity with applicable regulations and standards

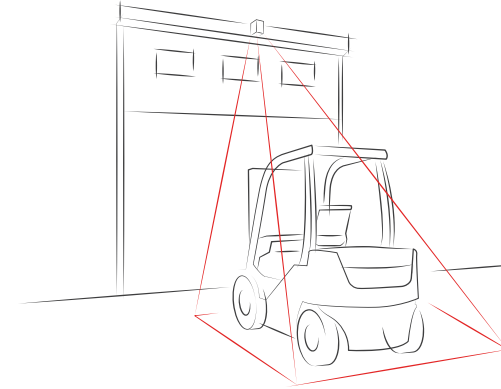
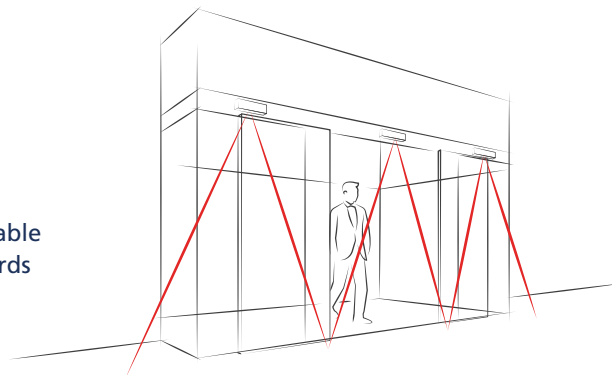

PRESENCE

We protect equipment and doors against damage

COUNTING

We accurately count people flow in many different environments

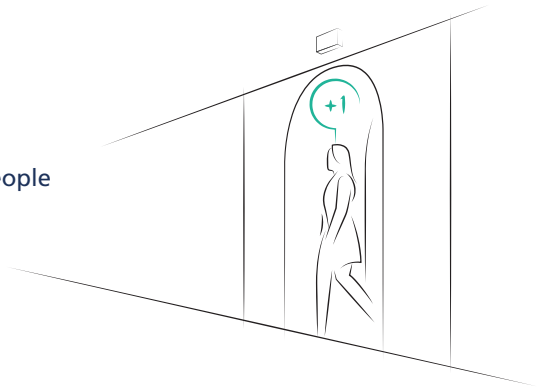

RAW DATA

We provide you with measurement data to develop your own application

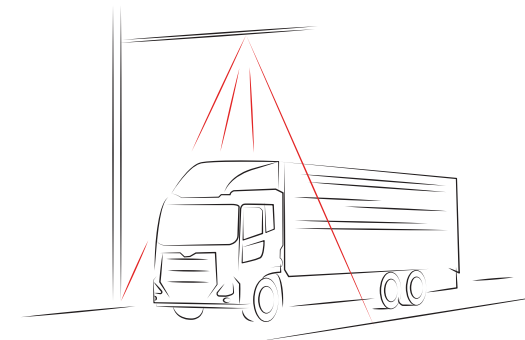

CONNECTIVITY

We optimize the installation of our products and invest in new communication technologies



BEHIND

THE SCENES

For more than 50 years, our engineers have been researching, developing and integrating the latest technologies into our products to create a diverse range of sensing solutions.

We were the first to use the accurate and fail-safe laser technology in door applications. For many years, radar or microwave technology has been detecting your every move and active infrared technology has proven to keep people safe and protect objects.



READY TO DETECT?

Our sensors detect motion, presence, flow of people, vehicles & objects.

- | | |
|-------------|------------------|
| 1. EAGLE | 6. IXIO |
| 2. FLATSCAN | 7. 4SAFE |
| 3. LZR | 8. CONDOR |
| 4. WIDESCAN | 9. RS-15 |
| 5. SIGMA | 10. MAGIC SWITCH |



1



2



3



6



7



4

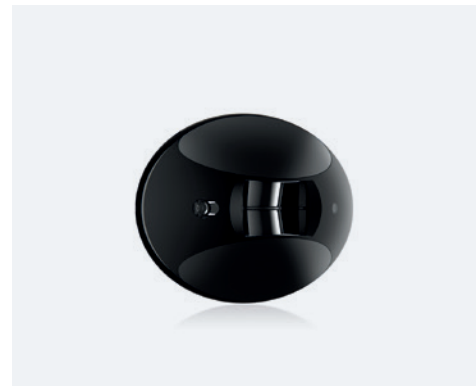

5



8



9



10

WE CREATE

*Peace
of Mind*

FOR YOUR FUTURE

BECAUSE

You have an eye for detail

Your sense for detail will drive our complete process from the development stage to the after-sales service stage. Our Product Management and Research & Development teams collaborate to provide you with high product usability, our production staff assemble all the pieces with great precision and our Sales and Customer Services teams listen to your specific needs, every day.



In all discretion

Our sensors are looking out for you in many different ways, even if you do not notice them. We aim at streamlined, compact and discrete product design, making sure that our sensors are well integrated into any environment.



Ready, Set, Go!

Intuitive and “plug & play” installation is essential to us, because we know how important it is to save valuable time.

Moreover, our in-house training sessions and online tutorials help the installer to become an expert.

We also work on our sensor connectivity to develop user-friendly interfaces, making the invisible visible.



WATCH OUR
TUTORIAL VIDEOS



TOMORROW IS ALREADY HERE

What we love above all is to surprise you.
We believe that innovation is the driving force behind success.
Year after year, we have developed state-of-the-art sensors
meeting market needs. What will come next?

*Let's shape
the future
together!*

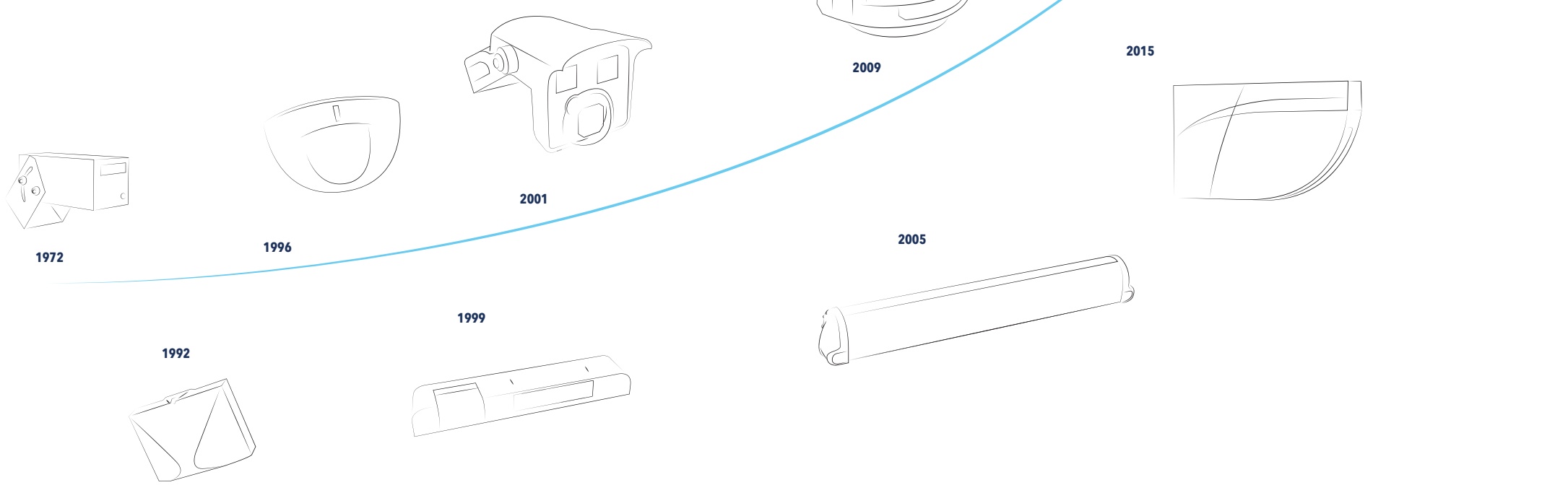

WE VALUE A

Close Relationship

IT'S IN OUR DNA

In a fast-moving environment, meeting you in person is the key to developing a strong and long-term partnership.

*We are pleased
to meet you,
listen to you
and collaborate
together.*



Our Passion HAS NO LIMITS

We are passionate about what we do and always interested in meeting new talent who share the same values. If you think you've got what it takes, we would love to hear from you.

Get in touch

& STAY TUNED

BEA EU Liège Science Park
Allée des Noisetiers 5
4031 Angleur • Belgium
T + 32 4 361 65 65
F + 32 4 361 28 58
E info@bea.be

BEA USA 100 Enterprise Drive
15275 Pittsburgh, PA • USA
T +1 4 12 249 4100
F +1 4 12 249 4101
E info@beainc.com

BEA APAC 4th, 5th Floor, M8 Building
No. 1 Jiuxianqiao East Road
Chaoyang District,
100015 Beijing • China
T + (86 10) 57 76 16 30
F + (86 10) 62 62 87 75
E info@beachina.cn



LINKEDIN
/company/bea-europe

BEA SENSORS EUROPE



YOUTUBE
/user/beacompany

BEA SENSORS EUROPE



NEWSLETTER
bea-sensors.com/en/newsletter



WWW.BEA-SENSORS.COM

WE CREATE
PEACE OF MIND



A Halma company

WWW.BEA-SENSORS.COM