

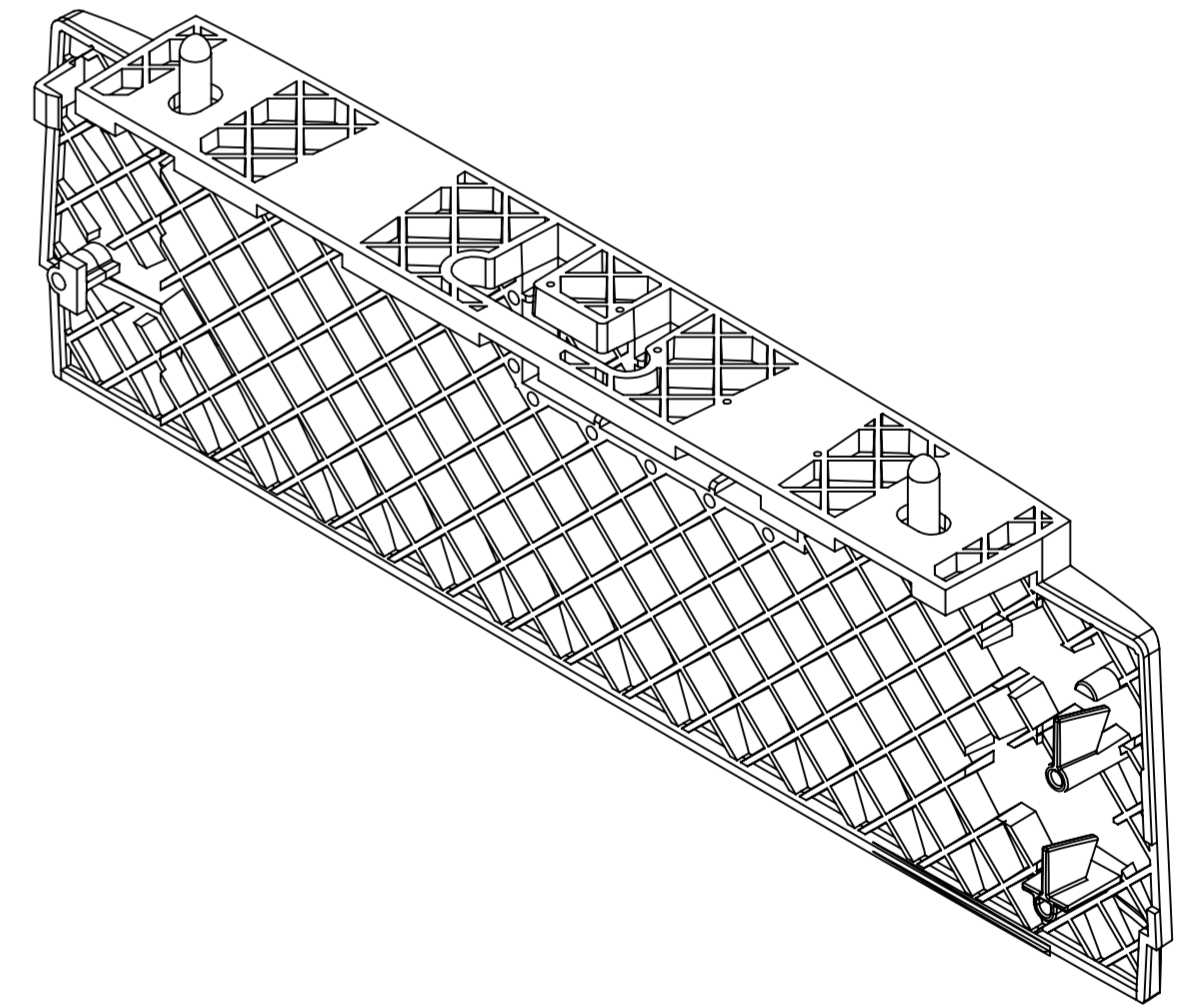

Part Volume : mm ³ - Part Weight : gr		DRAWER : NBE													
THIS DRAWING IS THE PROPERTY OF BEA AND MAY NOT BE REPRODUCED WITHOUT WRITTEN AGREEMENT															
MODIFICATIONS LIST															
<u>Date :</u>	<u>By :</u>	<u>Description :</u>	<u>Ver :</u>												
-	-	-	-												
-	-	-	-												
-	-	-	-												
-	-	-	-												
-	-	-	-												
 A HALMA COMPANY WWW.BEA.BE		PROD. NAME : E277 - Ixio S BA TITLE : External Dimensions GENERAL TOLERANCE : -	DATE : 25/04/2012 VERIFIED : APPROVED												
<table border="1"> <tr> <td>MATERIAL: -</td> <td colspan="3">TREATMENT: -</td> </tr> <tr> <td>Objet</td> <td>Ver.Obj</td> <td>Doc.</td> <td>Rev.Doc.</td> </tr> <tr> <td>41.8544 . A . PA . 01</td> <td></td> <td></td> <td></td> </tr> </table>		MATERIAL: -	TREATMENT: -			Objet	Ver.Obj	Doc.	Rev.Doc.	41.8544 . A . PA . 01				Scale : 1:1 Size : A2	PAGE: 1 / 2
MATERIAL: -	TREATMENT: -														
Objet	Ver.Obj	Doc.	Rev.Doc.												
41.8544 . A . PA . 01															

PDM Project : E277 - Ixio S BA - File Name : E41.8544 - External Dimensions

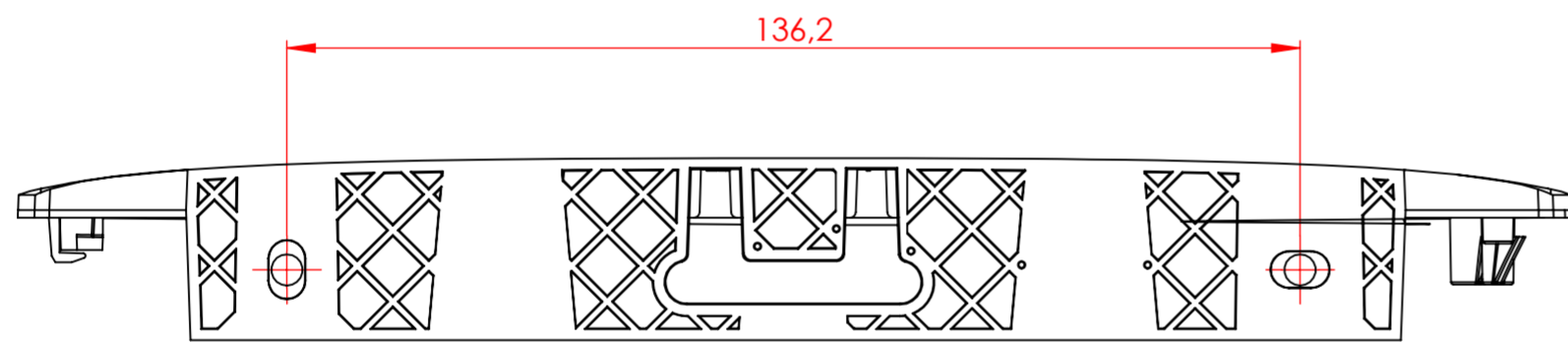
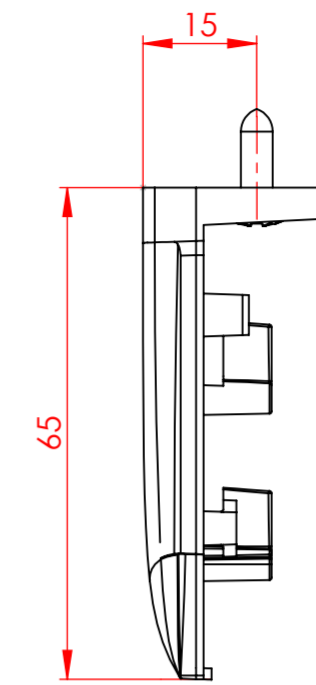
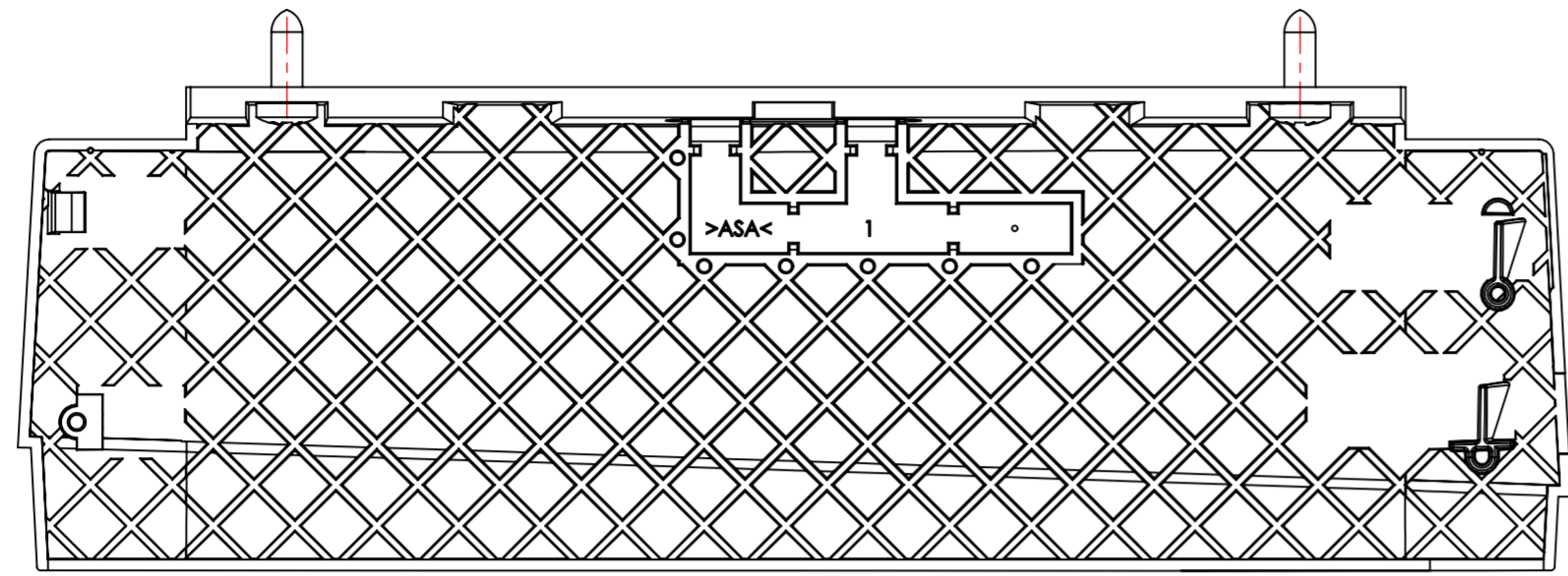

Part Volume : mm ³ - Part Weight : gr		DRAWER : NBE																	
THIS DRAWING IS THE PROPERTY OF BEA AND MAY NOT BE REPRODUCED WITHOUT WRITTEN AGREEMENT																			
MODIFICATIONS LIST																			
<i>Date :</i>	<i>By :</i>	<i>Description :</i>	<i>Ver :</i>																
-	-	-	-																
-	-	-	-																
-	-	-	-																
-	-	-	-																
-	-	-	-																
 A HALMA COMPANY WWW.BEA.BE		PROD. NAME : E277 - Ixio S BA TITLE : External Dimensions GENERAL TOLERANCE : -	DATE : 25/04/2012 VERIFIED : APPROVED																
<table border="1"> <tr> <th>MATERIAL :</th> <th colspan="3">TREATMENT :</th> </tr> <tr> <td>Objet</td> <td>Ver.Obj</td> <td>Doc.</td> <td>Rev.Doc.</td> </tr> <tr> <td colspan="2">41.8544 . A . PA . 01</td> <td>Scale</td> <td>Size</td> </tr> <tr> <td colspan="2"></td> <td>1:1</td> <td>A2</td> </tr> </table>		MATERIAL :	TREATMENT :			Objet	Ver.Obj	Doc.	Rev.Doc.	41.8544 . A . PA . 01		Scale	Size			1:1	A2		PAGE : 2 / 2
MATERIAL :	TREATMENT :																		
Objet	Ver.Obj	Doc.	Rev.Doc.																
41.8544 . A . PA . 01		Scale	Size																
		1:1	A2																

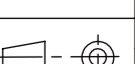
PDM Project : E277 - Ixio S BA - File Name : E41.8544 - External Dimensions