

LED-SIGNALS

	The ORANGE LED flashes every second.	The sensor goes into security mode.	1 Cut and restore power supply.
	The ORANGE LED flashes 1 x.	The sensor signals an internal fault.	1 Cut and restore power supply. 2 If orange LED flashes again, replace sensor.
	The ORANGE LED flashes 2 x.	Irregularities in the power supply	1 Check power supply. 2 Check wiring.
	The ORANGE LED flashes 4 x.	The sensor receives not enough IR-energy.	1 Use the 1 m prism if possible. 2 Check the angle of the IR-curtains.
	The ORANGE LED flashes 5 x.	The sensor receives too much IR-energy.	1 Use a low energy prism if possible. 2 Check the angle of the IR-curtains.
	The ORANGE LED flashes 6 x.	The radar sensor output is faulty.	1 Replace sensor.
	The ORANGE LED flashes 7 x.	The sensor is disturbed.	1 Change radar antenna angle.
	The ORANGE LED is on.	The radar sensor encounters a hardware problem.	1 Replace sensor.
	The ORANGE LED is on.	The sensor encounters a memory problem.	1 Cut and restore power supply. 2 If orange LED lights up again, replace sensor.
	The RED LED flashes quickly after an assisted setup.	The sensor sees the door during the assisted setup.	1 Check the angle of the IR-curtains. 2 Launch a new assisted setup. <i>Attention: Do not stand in the detection field!</i>
	The RED LED lights up sporadically.	The sensor vibrates.	1 Check if the sensor is fastened firmly. 2 Check position of prism and cover.
		The sensor sees the door.	1 Launch an assisted setup and adjust the IR angle.
		The sensor is disturbed by lamps or another sensor.	1 Choose a different frequency by remote control.
		The sensor is disturbed by the rain.	1 Increase the IR-immunity filter to value 2 or 3.
	The GREEN LED lights up sporadically.	The sensor is disturbed by rain and/or leaves.	1 Increase radar-immunity filter by remote control.
		Ghosting	1 Change radar antenna angle.
		The sensor vibrates.	1 Check if the sensor is fastened firmly. 2 Check position of cable and cover.
		The sensor sees the door or other moving objects.	1 Remove the objects if possible. 2 Change radar antenna. 3 Change radar field size (sensitivity).

Please keep for further use
Designed for colour printing



Other use of the device is outside the permitted purpose and can not be guaranteed by the manufacturer. The manufacturer cannot be held responsible for incorrect installations or inappropriate adjustments of the sensor.

ACTIV8 THREE PULSE

Opening & safety sensor
for automatic sliding doors in escape routes

DESCRIPTION

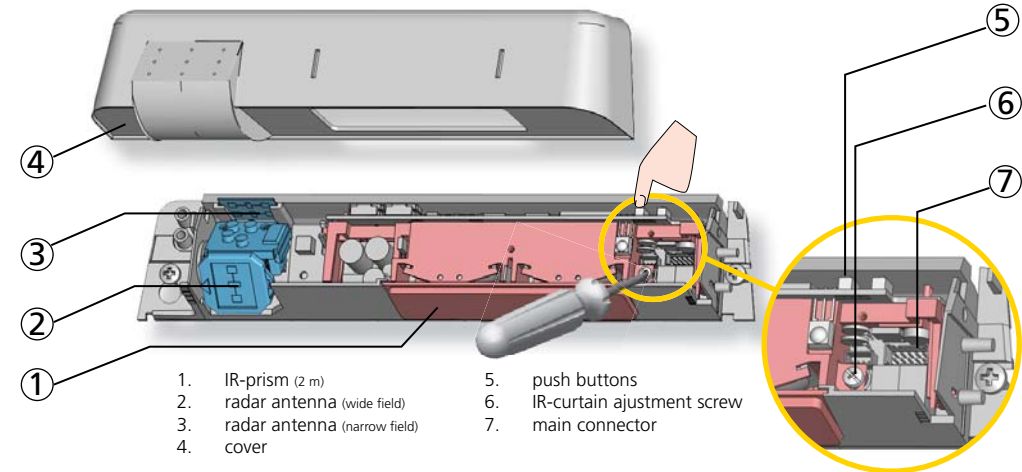

1. IR-prism (2 m)
2. radar antenna (wide field)
3. radar antenna (narrow field)
4. cover
5. push buttons
6. IR-curtain adjustment screw
7. main connector

TECHNICAL SPECIFICATIONS

Supply voltage:	12 V - 24 V AC +/-10% ; 12 V - 30 V DC -5%/+10% (to be operated from SELV compatible power supplies only)	
Power consumption:	< 3 W	
Mounting height:	1.8 m to 4 m (< 3 m to enable DIN 18650-conformity)	
Temperature range:	-25 °C to +55 °C	
Degree of protection:	IP54	
Expected lifetime:	5 years	
Norm conformity:	R&TTE 1999/5/EC; EMC 2004/108/EC; MD 2006/42/EC; EN 12978 EN ISO 13849-1:2008 Performance Level «d» CAT. 2 (under the condition that the door control system monitors the sensor at least once per door cycle)	
Detection mode:	Motion Min. detection speed: 5 cm/s	Presence Typical response time: <128 ms (max. 500 ms)
Technology:	Microwave doppler radar Transmitter frequency: 24.150 GHz Transmitter radiated power: < 20 dBm EIRP Transmitter power density: < 5 mW/cm ²	Active infrared with background analysis Spot diameter: 0.1 m (typ) Number of spots: 24 or 12 by curtain Number of curtains: 2
Angle:	From 15 ° to 50 ° vertical (adjustable)	From -4 ° to +4 ° (adjustable)
Hold time output signal:	0.5 s to 9 s (adjustable)	0.3 s to 1 s (not adjustable)
Output/Input:	Potential linked current source No detection: current source ON Max. open circuit voltage: 6.5 V Output voltage available at 10 mA: 3 V min. Typical load: up to 3 optocouplers in series Detection: current source OFF Leakage current: < 100 µA Open-circuit remained voltage: < 500 mV	Transistor (NPN open collector) requiring ext. pull-up resistor Max. output current: 25 mA Max. switching power: 40 V DC Max. pulse amplitude (detection state or fail state): 0,8 V Input Impedance: 100 kΩ Max. input voltage: 30 V DC External pull-up resistor: < 470 Ω (check compatibility) Min. Pulse amplitude (V _{pp}): > 50% of sensor supply voltage Max. Pulse duration: 100 µs @ 25 mA output current Min. time interval between pulses: > pulse duration

Specifications are subject to changes without prior notice.
All values measured in optimal conditions.

BEA SA | LIEGE Science Park | ALLÉE DES NOISSETIERS 5 - 4031 ANGLEUR [BELGIUM] | T +32 4 361 65 65 | F +32 4 361 28 58 | INFO@BEA.BE | WWW.BEA.BE



BEA hereby declares that the ACTIV8 THREE PULSE is in conformity with the basic requirements and the other relevant provisions of the directives 1999/5/EC, 2004/108/EC and 2006/42/EC.
Notified Body for EC inspection: 0044 - TÜV NORD CERT GmbH, Langemarckstr. 20, D-45141 Essen
Angleur, November 2010 Jean-Pierre Valkenberg, Authorized representative
The complete declaration of conformity is available on our website: www.bea.be



Only for EC countries: According to the European Guideline 2002/96/EC for Waste Electrical and Electronic Equipment (WEEE)

1 MOUNTING & WIRING

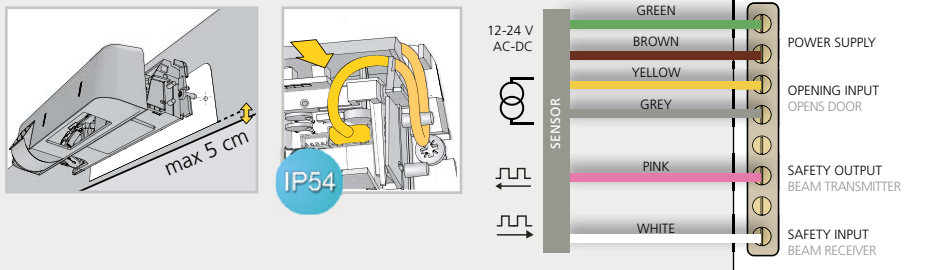

The door control unit and the door cover profile must be correctly earthed.

2 RADAR FIELD - OPENING IMPULSE

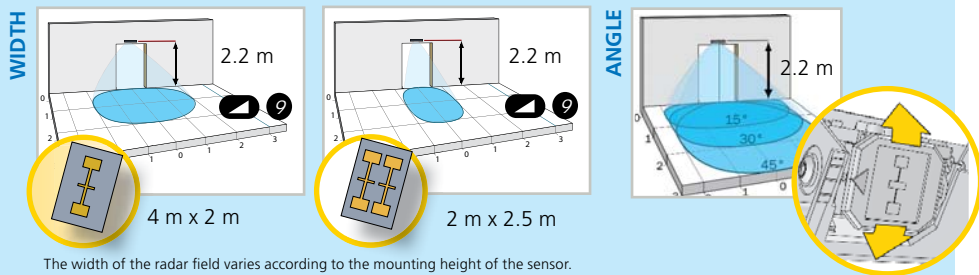

3 INFRARED FIELD - SAFETY

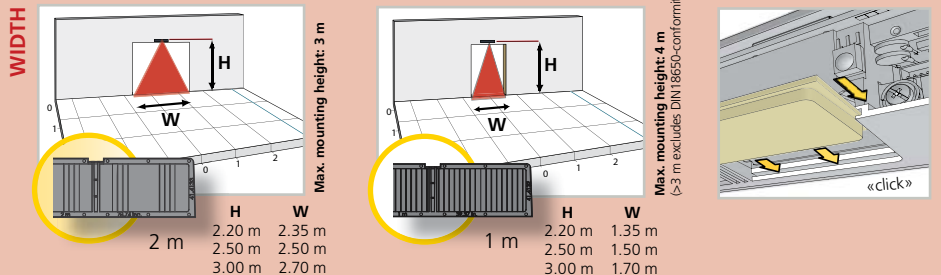

Detection field width indicated according to conditions defined in DIN 18650 and including dimension of test body CA.

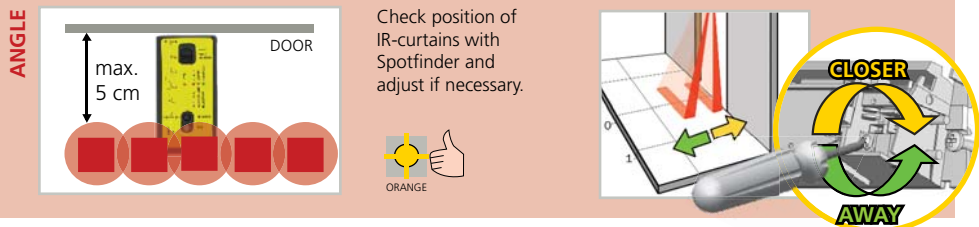

TIP: Launch an **ASSISTED SETUP** to verify wiring, position of the curtains and correct functioning of the sensor. It is recommended to clean the optical parts at least once a year or more often if required due to environmental conditions.

4 SETTINGS (by push buttons and/or remote control)

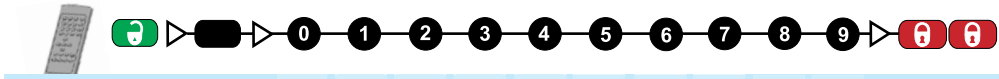
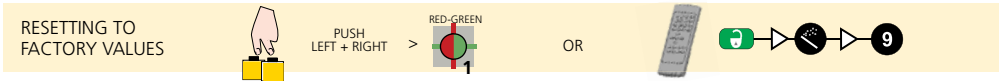
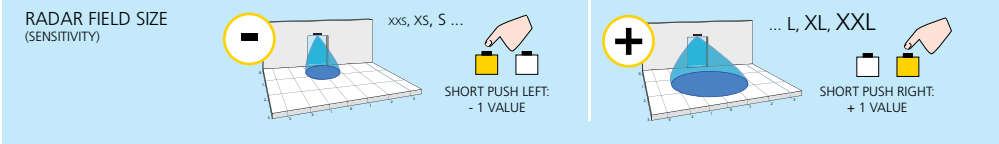

FIELD SIZE (SENSITIVITY)		XXS	XS	S	>	>	>	>	L	XL	XXL	L= 3.20 m x 1.40 m (at 2.2 m)
IMMUNITY FILTER			low	normal	high	>	>	>	>	>	>	
DETECTION MODE			bi	uni	uni PRM	bi = two-way detection; uni = one-way detection towards sensor; uni PRM = for persons with reduced mobility						
HOLD TIME OUTPUT SIGNAL		0.5 s	1 s	2 s	3 s	4 s	5 s	6 s	7 s	8 s	9 s	

OUTPUT REDIRECTION	F1	motion	motion or presence	opening output is active in case of:	0	1	motion detection	motion or presence detection
--------------------	-----------	--------	--------------------	--------------------------------------	---	---	------------------	------------------------------

NUMBER OF CURTAINS		service mode	1	2	dynamic mode	service mode = no detection is active during 15 minutes (maintenance). dynamic mode = 2 nd curtain is only active during motion detection.						
IMMUNITY FILTER*			normal	medium	high	>	>	>	>	immunity 3 is only suitable if a combined sensor is on each side of the door		
PULSE FREQUENCY			freq A		freq B		freq A+		freq B+			
MAX. PRESENCE TIME		30 s	1 min	2 min	5 min	10 min	20 min	60 min				

FACTORY VALUES (yellow background) excludes DIN18650-conformity of the door system (grey background)

5 SETUP (step out of the detection field during setup)

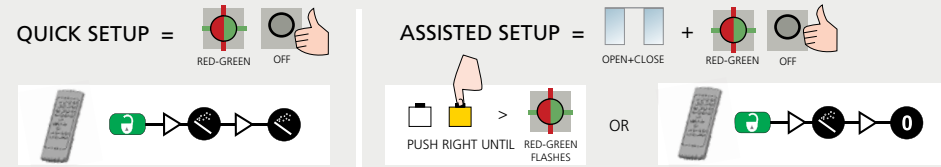

IMPORTANT: Test the good functioning of the installation before leaving the premises.

SAFETY INSTRUCTIONS
 The manufacturer of the door system is responsible for carrying out a risk assessment and installing the sensor and the door system in compliance with applicable national and international regulations and standards on door safety and if applicable, the machinery directive 2006/42/EC.
 Only trained and qualified personnel may install and setup the sensor.
 The warranty is void if unauthorized repairs are made or attempted by unauthorized personnel.
 Avoid touching any electronic and optical components.

* In immunity 2 and 3, the standard detection capability is the same as in immunity 1 (factory setting). Environmental and installation conditions can affect the detection capability of the sensor or can impact the availability of the door system. During harsh conditions, the sensor can temporarily adapt the detection capability to ensure the availability of the door system.