

LED-SIGNALS

	The ORANGE LED flashes every second.	The sensor goes into security mode.	<ol style="list-style-type: none"> 1 Cut and restore power supply.
	The ORANGE LED flashes 1 x.	The sensor signals an internal fault.	<ol style="list-style-type: none"> 1 Cut and restore power supply. 2 If orange LED flashes again, replace sensor.
	The ORANGE LED flashes 2 x.	Irregularities in the power supply	<ol style="list-style-type: none"> 1 Check power supply. 2 Check wiring.
	The ORANGE LED flashes 4 x.	The sensor receives not enough IR-energy.	<ol style="list-style-type: none"> 1 Use the 1 m prism if possible. 2 Check the angle of the IR-curtains.
	The ORANGE LED flashes 5 x.	The sensor receives too much IR-energy.	<ol style="list-style-type: none"> 1 Use a low energy prism if possible. 2 Check the angle of the IR-curtains.
	The ORANGE LED is on.	The sensor encounters a memory problem.	<ol style="list-style-type: none"> 1 Cut and restore power supply. 2 If orange LED lights up again, replace sensor.
	The RED LED flashes quickly after an assisted setup.	The sensor sees the door during the assisted setup.	<ol style="list-style-type: none"> 1 Check the angle of the IR-curtains. 2 Launch a new assisted setup. Attention: Do not stand in the detection field!
	The RED LED lights up sporadically.	The sensor vibrates.	<ol style="list-style-type: none"> 1 Check if the sensor is fastened firmly. 2 Check position of prism and cover.
		The sensor sees the door.	<ol style="list-style-type: none"> 1 Launch an assisted setup and adjust the IR angle.
		The sensor is disturbed by lamps or another sensor.	<ol style="list-style-type: none"> 1 Choose a different frequency by remote control.
		The sensor is disturbed by the rain.	<ol style="list-style-type: none"> 1 Increase the IR-immunity filter to value 2 or 3. 2 Select presetting 2 or 3 by push button.
	The LED is off.		<ol style="list-style-type: none"> 1 Check connections to test output. 2 If your door controller is not able to test the sensor, connect the red and blue cable to power supply.*
	The reaction of the door does not correspond to the LED-signal.		<ol style="list-style-type: none"> 1 Check output configuration setting. 2 Switch value 1 (A-P) to 4 (A-A) or 4 to 1 by remote control.

*excludes DIN18650-conformity of the door system



SAFETY INSTRUCTIONS

The manufacturer of the door system is responsible for carrying out a risk assessment and installing the sensor and the door system in compliance with applicable national and international regulations and standards on door safety and if applicable, the machinery directive 2006/42/EC.

Only trained and qualified personnel may install and setup the sensor.

The warranty is void if unauthorized repairs are made or attempted by unauthorized personnel.

Avoid touching any electronic and optical components.

BEA SA | LIEGE Science Park | ALLÉE DES NOISÉTIERS 5 - 4031 ANGLEUR (BELGIUM) | T +32 4 361 65 65 | F +32 4 361 28 58 | INFO@BEA.BE | WWW.BEA.BE



BEA hereby declares that the IRIS ON C SL is in conformity with the basic requirements and the other relevant provisions of the directives 2004/108/EC and 2006/42/EC.

Notified Body for EC inspection: 0044 - TÜV NORD CERT GmbH, Langemarckstr. 20, D-45141 Essen

Angleur, November 2010 Jean-Pierre Valkenberg, Authorized representative

The complete declaration of conformity is available on our website: www.bea.be



Only for EC countries: According to the European Guideline 2002/96/EC for Waste Electrical and Electronic Equipment (WEEE)



Please keep for further use
Designed for colour printing



Other use of the device is outside the permitted purpose and can not be guaranteed by the manufacturer. The manufacturer cannot be held responsible for incorrect installations or inappropriate adjustments of the sensor.

IRIS ON C SL

Safety sensor for automatic sliding doors

DESCRIPTION

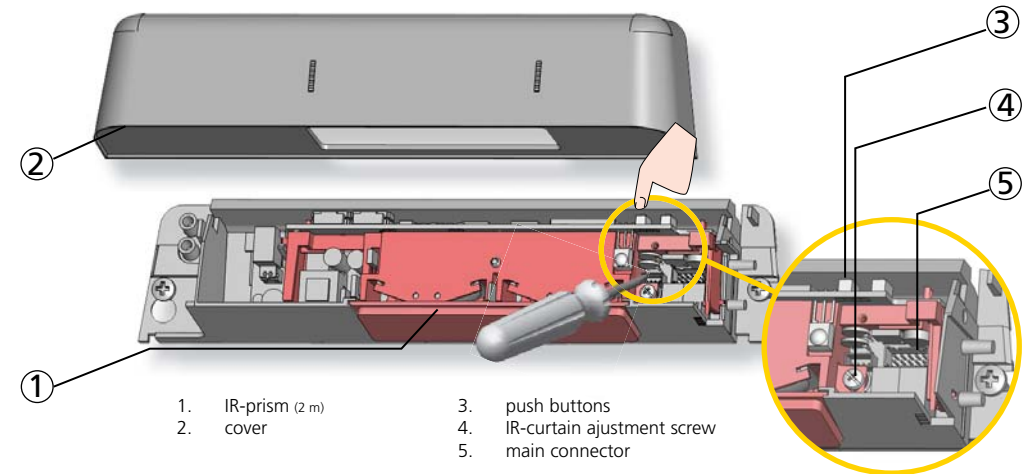

TECHNICAL SPECIFICATIONS

Supply voltage:	12 V - 24 V AC +/-10% ; 12 V - 30 V DC -5%/+10% (to be operated from SELV compatible power supplies only)
Power consumption:	< 3 W
Mounting height:	1.8 m to 4 m (< 3 m to enable DIN 18650-conformity)
Sensitivity of the test input:	< 1 V : Log. L; > 10 V: Log. H (max. 30 V)
Temperature range:	-25 °C to +55 °C
Degree of protection:	IP54
Expected lifetime:	5 years
Norm conformity:	EMC 2004/108/EC; MD 2006/42/EC; EN 12978 EN ISO 13849-1:2008 Performance Level «C» CAT. 2 (under the condition that the door control system monitors the sensor at least once per door cycle)
Detection mode:	Presence Typical response time: <128 ms (max. 500 ms)
Technology:	Active infrared with background analysis Spot diameter: 0.1 m (typ) Number of spots: 24 or 12 by curtain Number of curtains: 2
Angle:	From -4 ° to +4 ° (adjustable)
Output:	Solid-state-relay (free of potential, free of polarity) Max. contact current: 100 mA Max. contact voltage: 42 V AC/DC
Hold time output signal:	0.3 s to 1 s (not adjustable)
Response time on test request:	Typical: < 15 ms (max. 25 ms)

Specifications are subject to changes without prior notice.
All values measured in optimal conditions.

1 MOUNTING & WIRING

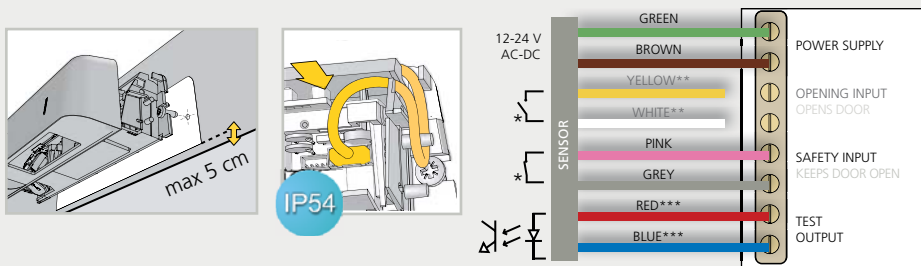

The door control unit and the door cover profile must be correctly earthed.

* Output status when sensor is operational
 ** Connect to launch an assisted setup.
 *** For compliance with DIN 18650, connection to door controller test output is required.

2 INFRARED FIELD - SAFETY

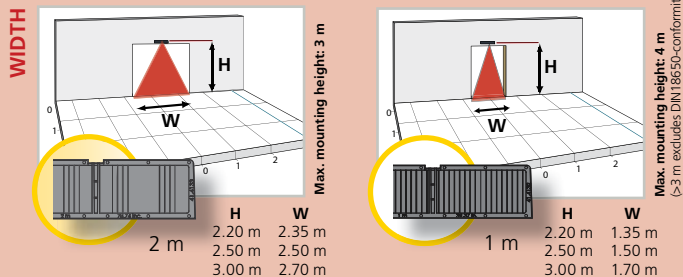

Detection field width indicated according to conditions defined in DIN 18650 and including dimension of test body CA.

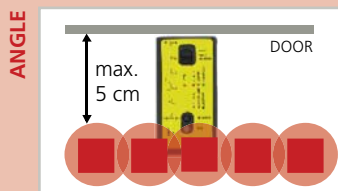

Check position of IR-curtains with Spotfinder and adjust if necessary.

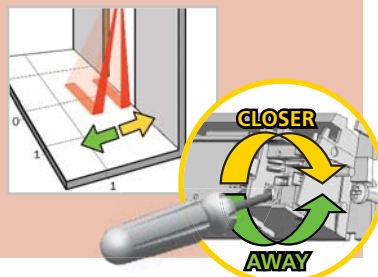

TIP: Launch an **ASSISTED SETUP** to verify wiring, position of the curtains and correct functioning of the sensor. It is recommended to clean the optical parts at least once a year or more often if required due to environmental conditions.

3 SETTINGS (by push buttons and/or remote control)

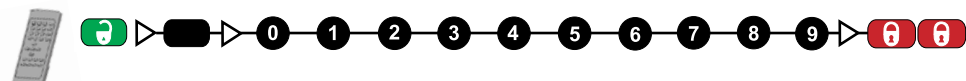
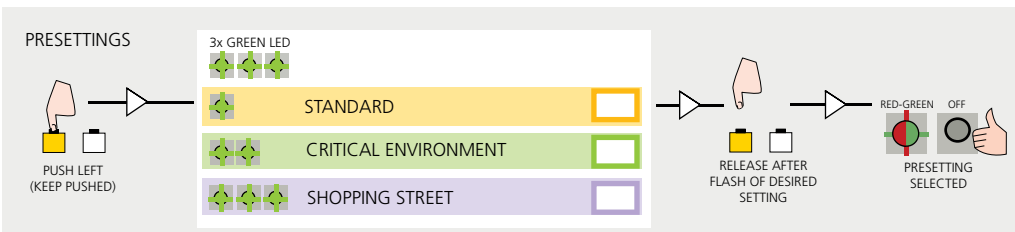

TEST (MONITORING)		off	on	auto	auto = the sensor will automatically adapt to the door controller: when the door controller monitors the sensor > on when the door controller does not monitor the sensor > off (excludes DIN18650-conformity)		
OUTPUT CONFIGURATION			A-P	P-A	P-P	A-A	A = active output (NO-contact) P = passive output (NC-contact)
OUTPUT REDIRECTION			safety	safety + opening			0 presence detection on safety input 1 presence detection on safety and opening input

NUMBER OF CURTAINS		service mode	1	2	service mode = no detection is active during 15 minutes (maintenance).					
IMMUNITY FILTER*			normal	medium	high	>	>	>	>	immunity 3 is only suitable if a combined sensor is on each side of the door
PULSE FREQUENCY			freq A	freq B	freq A+	freq B+				
MAX. PRESENCE TIME			30 s	1 min	2 min	5 min	10 min	20 min	60 min	

FACTORY VALUES (yellow background) excludes DIN18650-conformity of the door system (grey background)

* In immunity 2 and 3, the standard detection capability is the same as in immunity 1 (factory setting). Environmental and installation conditions can affect the detection capability of the sensor or can impact the availability of the door system. During harsh conditions, the sensor can temporarily adapt the detection capability to ensure the availability of the door system.

4 SETUP (step out of the detection field during setup)

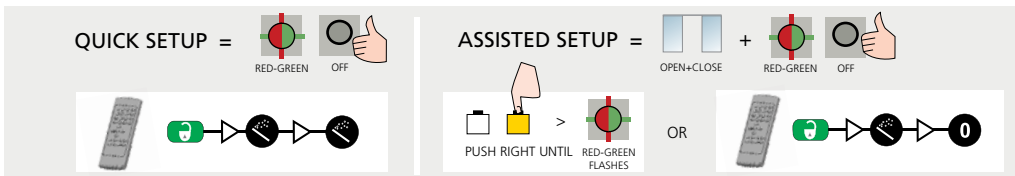

IMPORTANT: Test the good functioning of the installation before leaving the premises.