

Quick Start

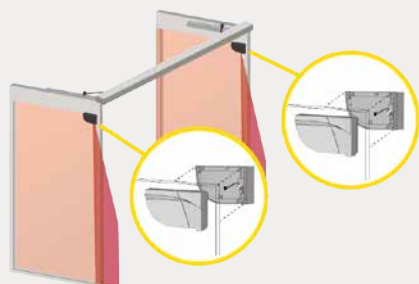

SLAVE

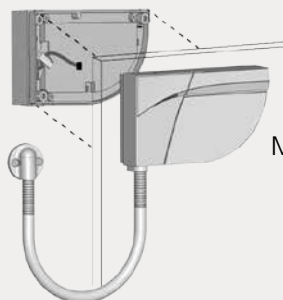

MASTER

1 MOUNTING ON DOOR

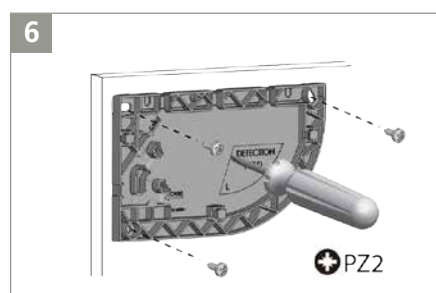
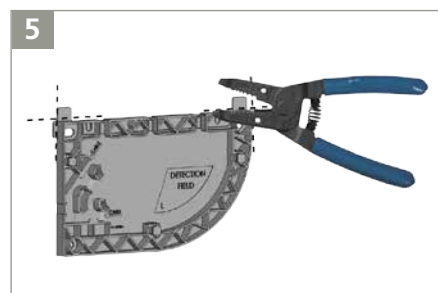
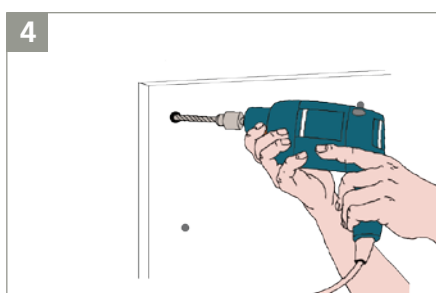
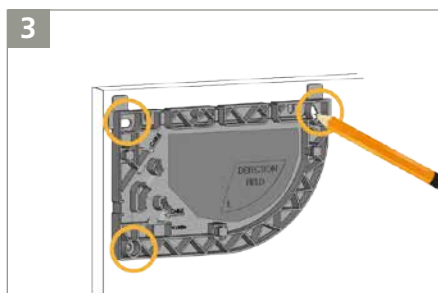
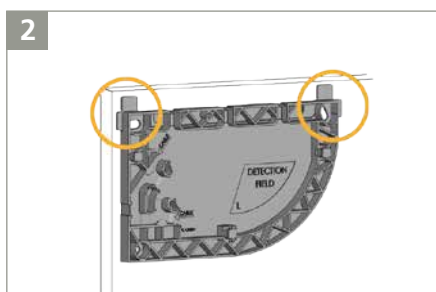
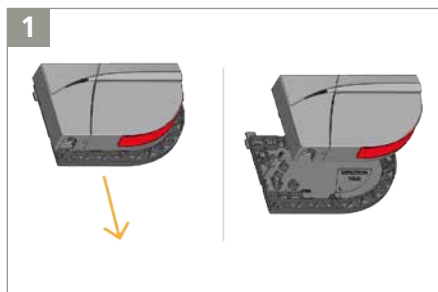

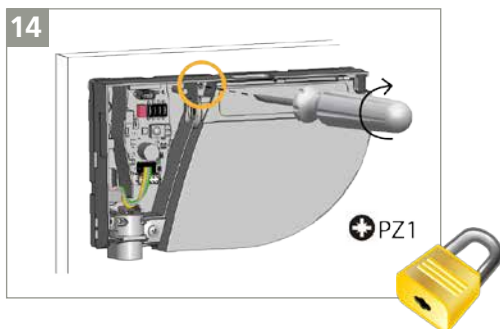
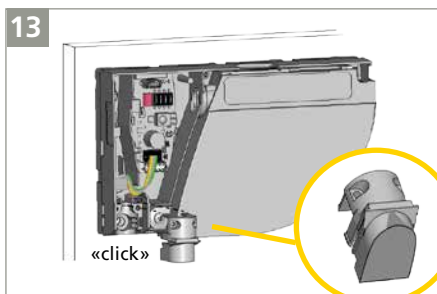
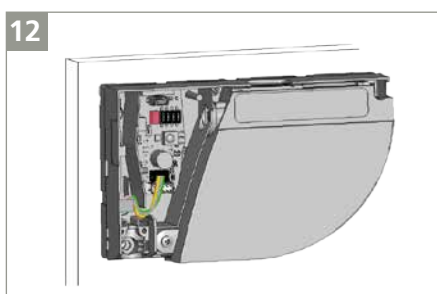
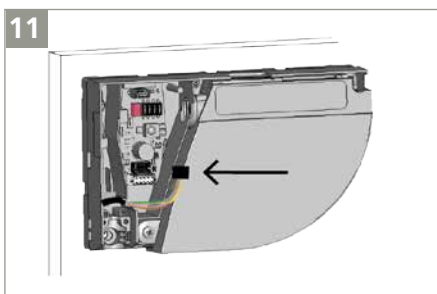
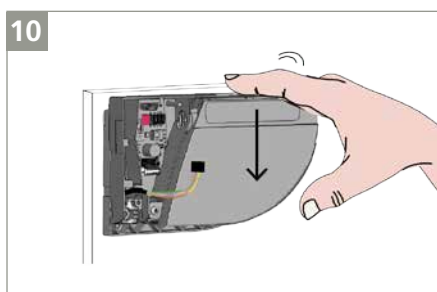
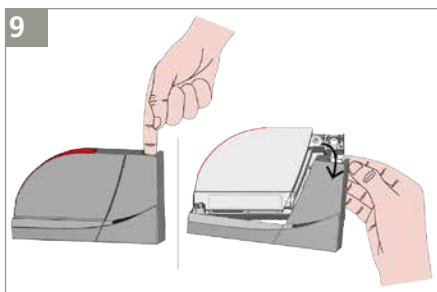
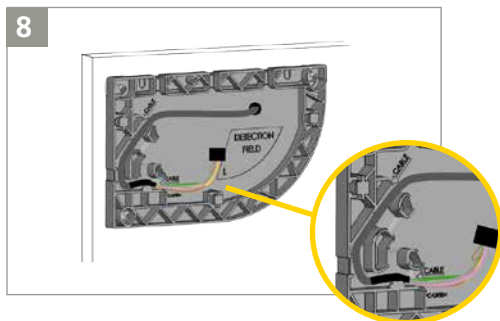
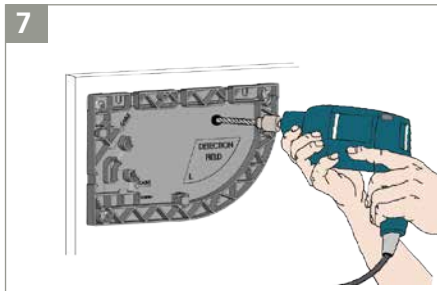

2 WIRING TO DOOR CONTROLLER

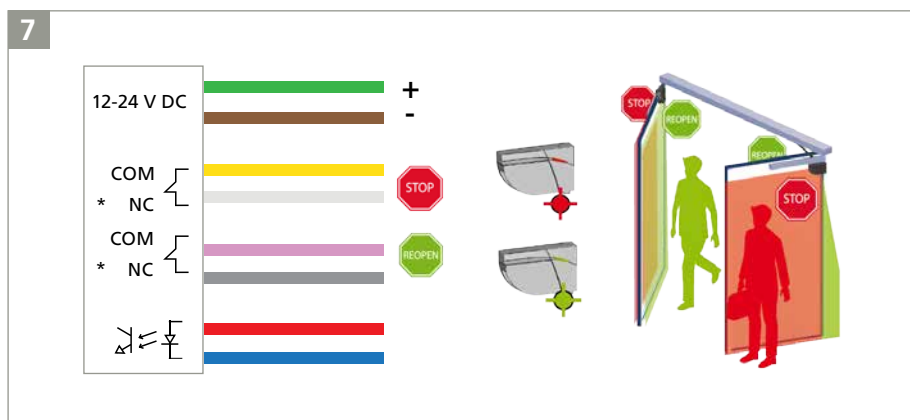
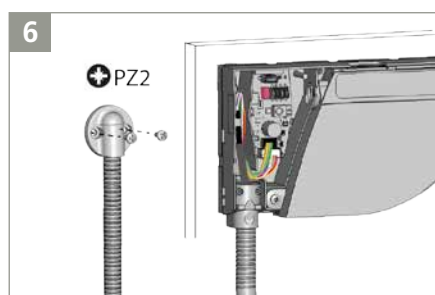
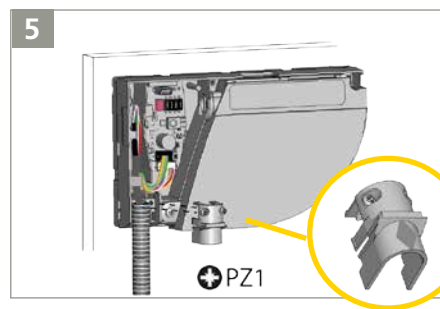
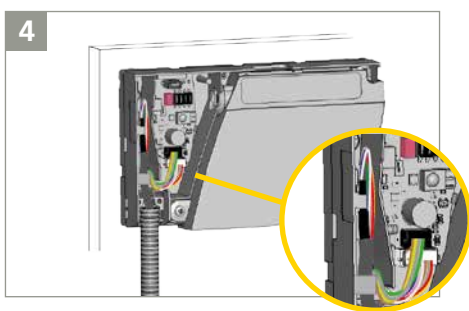
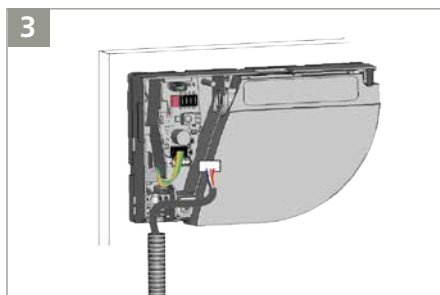
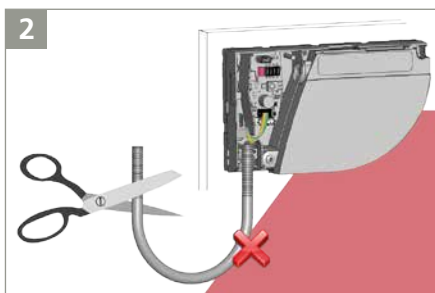
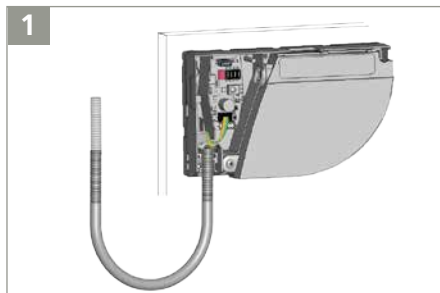

3 DIP1

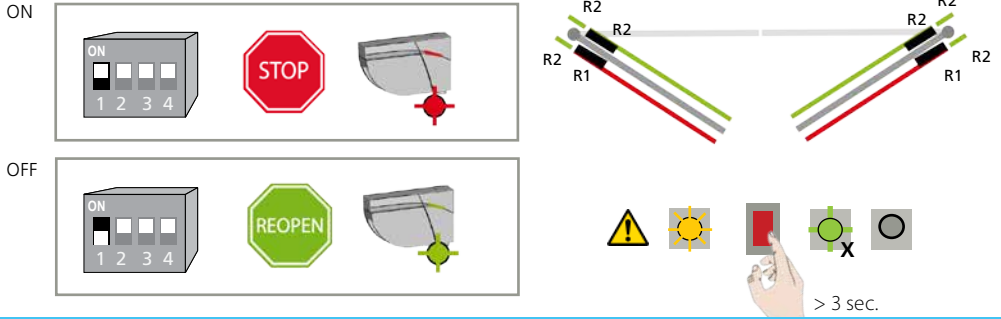

4 TEACH-IN

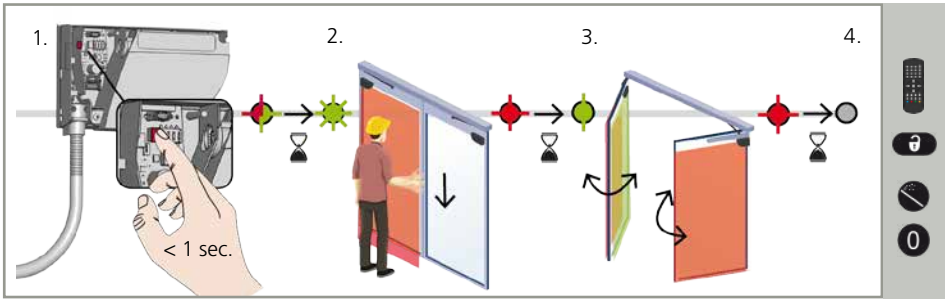

5 TEST + ADJUSTMENTS

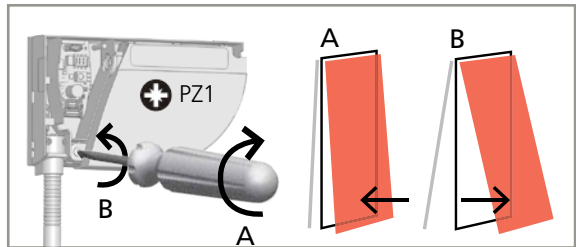

⚠ Start new TEACH-IN

6 FINAL STEPS

