

# 4SAFE ON REV

## SAFETY SENSOR FOR AUTOMATIC REVOLVING DOORS

User's Guide for product version 0500 and higher  
See product label for serial number



### DESCRIPTION

The 4SAFE ON REV is a safety sensor for automatic revolving doors based on active infrared technology. It secures the area in front of the moving door leaf. To do so, modules must be installed on the top rail of the door leaf.

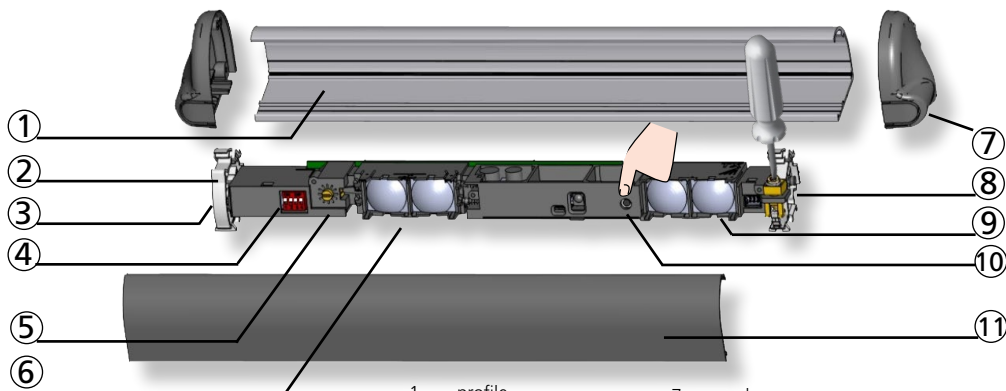

- |                      |                                     |
|----------------------|-------------------------------------|
| 1. profile           | 7. end cap                          |
| 2. supporting clip   | 8. clip with angle adjustment screw |
| 3. main connector    | 9. transmitter (TX)                 |
| 4. DIP-switch        | 10. push button                     |
| 5. calibration screw | 11. front face                      |
| 6. receiver          |                                     |

### TECHNICAL SPECIFICATIONS

Technology:	active infrared with background suppression
Emission field:	400 mm (W) x 70 mm (D) (at 2 m mounting height; 4 spots active)
Mounting height:	1.3 m to 3.5 m
Reaction time:	64 ms (typ)
Max. presence time:	1 minute
Supply voltage:	12 V - 24 V AC +/-10% ; 12 V - 30 V DC -5%/+10% (to be operated from SELV compatible power supplies only)
Max current consumption:	95 mA @ 24 V AC/ 70 mA @ 24 V DC; 170 mA @ 12 V AC/ 130 mA @ 12 V DC (MASTER) 85 mA @ 24 V AC/ 60 mA @ 24 V DC; 180 mA @ 12 V AC/ 113 mA @ 12 V DC (other modules)
Output:	2 relays (free of potential contact)
Max. contact voltage	42 V AC/DC
Max. contact current	1 A (resistive)
Max. switching power	30 W (DC) / 42 VA (AC)
Input:	1 optocoupler (free of potential contact)
Max. contact voltage:	30 V
Voltage threshold:	high: >10 V DC; low: <1 V DC
Max. number of modules:	4 (up to 6 if 24 V DC)
Reflectivity:	min. 5% at IR-wavelength of 850 nm
Degree of protection:	IP54
Temperature range:	-25 °C to +55 °C; 0-95% relative humidity, non condensing
Expected lifetime:	20 years
Conformity:	DIN 18650-1: ch. 5.7.4; EN 16005 ch. 4.6.8; EN 12978; IEC/EN 61508 (SIL2) EN ISO 13849-1 Performance Level «C» CAT. 2 (under the condition that the door control system monitors the sensor at least once per door cycle)

# 1 MOUNTING THE PROFILE



Mount the profiles as close as possible to the closing edge. Leave 2 cm for the black end caps. Take the position of the white clips into account before drilling and fastening the screws.

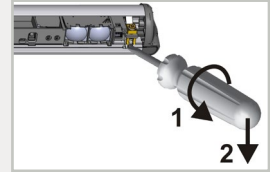

To loosen the modules, please use a screwdriver.

# 2 POSITIONING THE MODULES

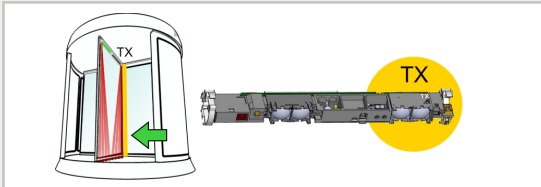

Place the transmitter (TX) next to the door edges that needs to be protected.

Position the angle adjustment clip next to the transmitter.

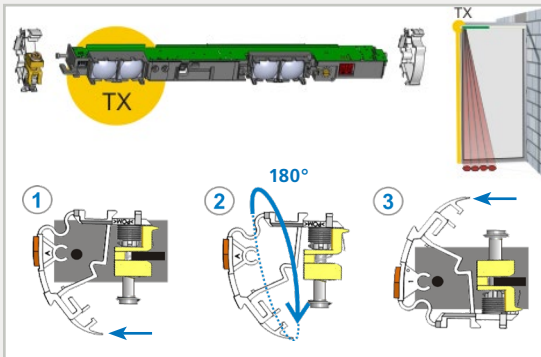

If necessary, turn the module and reposition the clips as indicated.

1. Detach the clips
2. Turn them by 180°
3. Reattach

# 3 WIRING

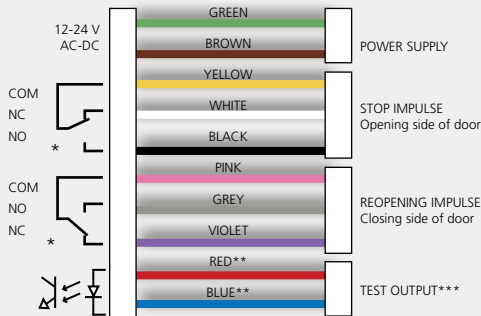

The module connected to the door controller becomes the **MASTER**.

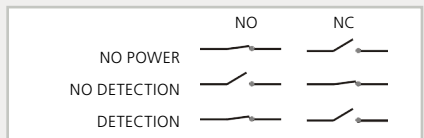

Plug the SLAVE CABLE between the modules in one of the two placements.

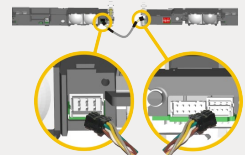

\* Output status when sensor is operational

\*\* For compliance with EN 16005 and DIN 18650, connection to door controller test output is required.

\*\*\* If door controller is not tested: connect BLUE to 0 V and RED to +12 V - 30 V DC.

## 4 SETTINGS

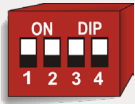

ON

MOUNTING  
SIDE

RELAY 1  
STOP



FREQUENCY

FREQ A

BACKGROUND

ON

UNCOVERED  
ZONE

HIGH\*

OFF

RELAY 2  
REOPENING



FREQ B

OFF

LOW

FACTORY VALUE

LED during detection:  
R1 > RED  
R2 > GREEN

Set different frequencies on modules close to each other.

Not enough background reflectivity: switch to OFF

Approximate values at 2 m: high= 40 cm, low = 15 cm

\* Recommended for most applications. Mounting height > 2.7 m: set to LOW for EN 16005 and DIN 18650-conformity.

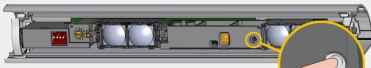

After changing a DIP-switch, the orange LED flashes.



ORANGE

GREEN

OFF

A LONG push on the push button of the **MASTER** confirms the settings of ALL MODULES.

Afterwards, a number of green flashes (x) indicates the number of connected modules.

## 5 CALIBRATION



A SHORT push on the button of the **MASTER** launches a calibration on ALL MODULES.

Do not stand in the detection field!



RED-GREEN



OFF

When the LED is off on all modules, the detection zone is OK.



GREEN

The detection zone is too short: turn the screw clockwise.



RED

The detection zone is too long: turn the screw anticlockwise.



ORANGE

Step out of the detection field.

If necessary, change angle or switch off background (DIP 3 = OFF).



ORANGE

Launch a new calibration.

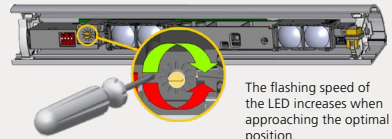

The flashing speed of the LED increases when approaching the optimal position.

## 6 DOOR SAFETY CHECK

**IMPORTANT:** Test the good functioning of the installation before leaving the premises.

If necessary, position spots closer to or away from the door and **relaunch a calibration**.

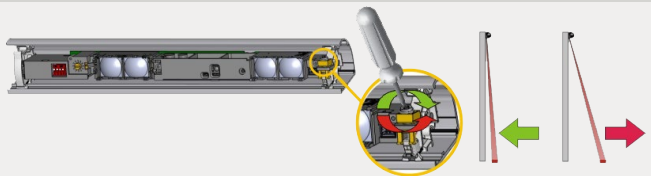

## LED-SIGNALS

 	The RED or GREEN LED is ON sporadically or permanently.	Bad calibration	<ol style="list-style-type: none"> <li>1 Launch a calibration.</li> </ol>
		Bad adjustment of the uncovered zone.	<ol style="list-style-type: none"> <li>1 Check if the DIP-switch 4 is in correct position.</li> <li>2 Launch a calibration.</li> </ol>
		The sensor is disturbed by lamps or another sensor.	<ol style="list-style-type: none"> <li>1 Select a different frequency for each module (DIP 2).</li> <li>2 Launch a calibration.</li> </ol>
	The sensor does not react, but a calibration can be launched.	The monitoring is activated, but the test input is not powered.	<ol style="list-style-type: none"> <li>1 Check wiring.           <ul style="list-style-type: none"> <li>- Door control with test: Connect RED and BLUE wires to test output.</li> <li>- Door control without test: Connect BLUE to 0 V and RED to +12 V - 30 V DC.</li> </ul> </li> </ol>
	The ORANGE LED is on permanently.	The sensor encounters a memory problem.	<ol style="list-style-type: none"> <li>1 Send the sensor back for a technical check-up.</li> </ol>
	The ORANGE LED flashes quickly.	DIP-switch setting awaiting confirmation.	<ol style="list-style-type: none"> <li>1 Confirm the DIP-switch setting: long push on the push button.</li> </ol>
	The ORANGE LED flashes 1 x every 3 seconds.	The sensor signals an internal fault.	<ol style="list-style-type: none"> <li>1 Cut and restore power supply.</li> <li>2 If orange LED flashes again, replace sensor.</li> </ol>
	The ORANGE LED flashes 2 x every 3 seconds.	Power supply is out of limit.	<ol style="list-style-type: none"> <li>1 Check power supply (tension, capacity).</li> <li>2 Reduce the cable length or change cable.</li> </ol>
	The ORANGE LED flashes 3 x every 3 seconds.	Communication error between modules.	<ol style="list-style-type: none"> <li>1 Check wiring between modules.</li> <li>2 Launch a module count: long push on push button of MASTER.</li> </ol>
	The ORANGE LED flashes 4 x every 3 seconds.	The sensor receives not enough IR-energy.	<ol style="list-style-type: none"> <li>1 Launch a new calibration and step out of the detection field.</li> <li>2 Change angle of spots.</li> <li>3 Switch off background (DIP 3: OFF).</li> </ol>
	The ORANGE LED flashes 5 x every 3 seconds.	Calibration error	<ol style="list-style-type: none"> <li>1 Check mounting height.</li> <li>2 Change position of calibration screw.</li> <li>3 Launch a new calibration.</li> <li>4 Switch off background (DIP3: OFF)</li> </ol>

- The device cannot be used for purposes other than its intended use. All other uses cannot be guaranteed by the manufacturer of the sensor.
- The manufacturer of the door system is responsible for carrying out a risk assessment and installing the sensor and the door system in compliance with applicable national and international regulations and standards on door safety.
- The manufacturer of the sensor cannot be held responsible for incorrect installations or inappropriate adjustments of the sensor.
- Only trained and qualified personnel may install and setup the sensor.
- The warranty is invalid if unauthorized repairs are made or attempted by unauthorized personnel.



BEA hereby declares that the 4SAFE ON REV is in compliance with European directives 2014/30/EU (EMC), 2006/42/EC (Machinery) and 2011/65/EU (RoHS).

Notified Body for EC inspection: 0044 - TÜV NORD CERT GmbH, Langemarkstr. 20, D-45141 Essen

EC-Type examination certificate number : 44 205 13089630

Pierre Gardier, Angleur, December 2018

The full text of the EU declaration of conformity is available on our website.

This product should be disposed of separately from unsorted municipal waste

