

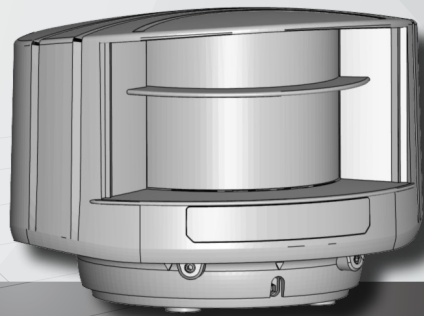

EN



LZR[®]-P110

LASER SCANNER FOR PEDESTRIAN DOORS

User's Guide for software version 0600 and higher
See tracking label on product for serial number



SLIDING



SWINGING



REVOLVING

SAFETY



The device emits invisible IR and visible laser radiation.
 IR laser: wavelength 905nm; output power <math><0.10\text{ mW}</math>
 (Class 1 according to IEC 60825-1)
 Visible laser: wavelength 635 nm; max. output power <math><1\text{ mW}</math>
 (Class 2 according to IEC 60825-1)

The visible laser beams are inactive during normal functioning.
 The installer can activate the visible lasers if needed.
 Do not stare into visible laser beams.



CAUTION!

Use of controls, adjustments or performance of procedures other than those specified herein may result in hazardous radiation exposure.

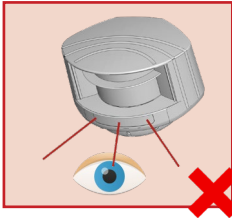

Do not stare into the visible red laser beams.

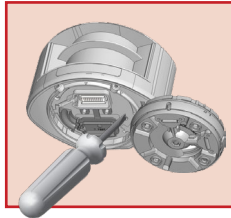

The warranty is void if unauthorized repairs are made or attempted by unauthorized personnel.



Only trained and qualified personnel may install and adjust the sensor.

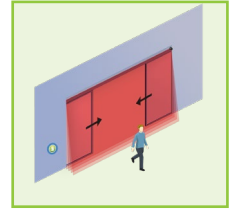

Test the good functioning of the installation before leaving the premises.

The manufacturer of the door system is responsible for carrying out a risk assessment and installing the sensor and the door system in compliance with applicable national and international regulations and standards on door safety. Other use of the device is outside the permitted purpose and can not be guaranteed by the manufacturer. The manufacturer cannot be held responsible for incorrect installations or inappropriate adjustments of the sensor.

INSTALLATION AND MAINTENANCE

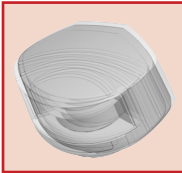

Avoid extreme vibrations.

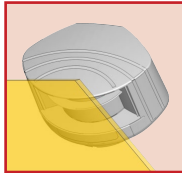

Do not cover the front screens.

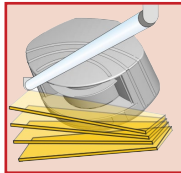

Avoid moving objects and light sources in the detection field.

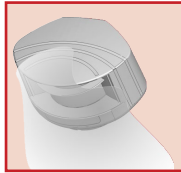

Avoid the presence of smoke and fog in the detection field.

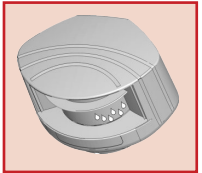

Avoid condensation.

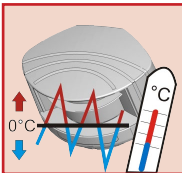

Avoid exposure to sudden and extreme temperature changes.

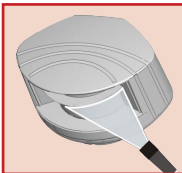

Avoid direct exposure to high pressure cleaning.



Do not use aggressive products to clean the front screens.

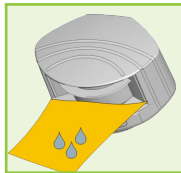

Wipe the front screens regularly with a clean and damp cloth.

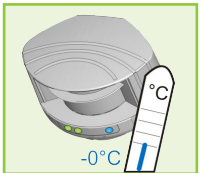

Keep the sensor permanently powered in environments where the temperature can descend below -10°C .

DESCRIPTION

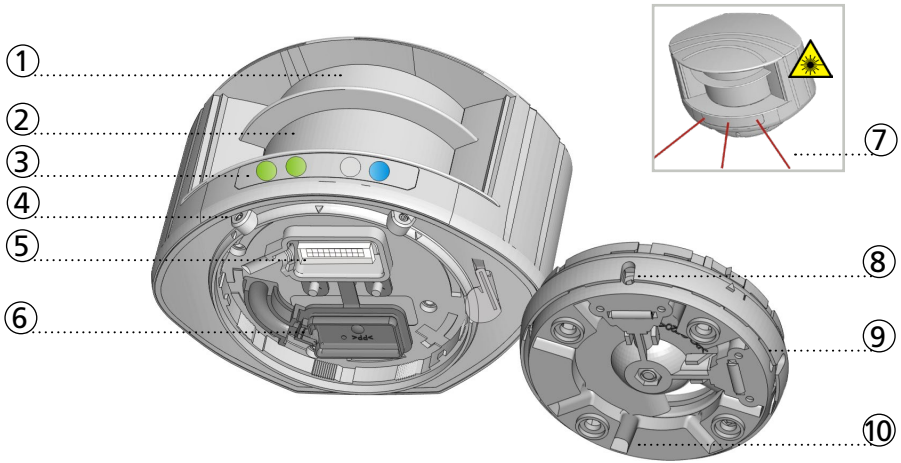

- | | |
|---------------------------------|--|
| 1. laser sweep emission | 6. protection cover |
| 2. laser sweep reception | 7. visible laser beams (3) |
| 3. LED-signals (4) | 8. notches for tilt angle adjustment (2) |
| 4. screws for position lock (2) | 9. adjustable bracket |
| 5. connector | 10. cable conduits (4) |

LED-SIGNAL

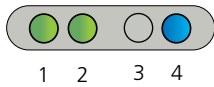

1. Detection LED: relay 1 - optional field
2. Detection LED: relay 2 - safety field
3. Error LED
4. Power LED

DETECTION LEDs

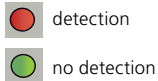

ERROR LED

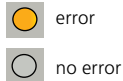

POWER LED

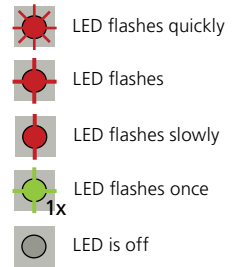
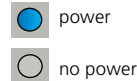

All 4 LEDs can be switched off and on again by remote control. This can be useful in cases where the sensor should not draw any attention.

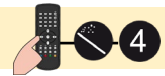

SYMBOLS



Caution!
Laser radiation



Attention!
Important!



Tip
Info

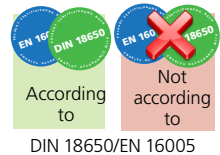

Remote control
sequence



Possible
remote control
adjustments



Important
remote control
sequence



Factory
values

HOW TO USE THE REMOTE CONTROL



4 hours after last use, the sensor locks the access to the remote control session. Cut and restore power supply. The remote control session is accessible again during 4 hours.



After unlocking, the red LED flashes and the sensor can be adjusted by remote control.



If the red LED flashes quickly after unlocking, you need to enter an access code from 1 to 4 digits.



To end an adjustment session, always lock the sensor.

SAVING AN ACCESS CODE

The access code is recommended for sensors installed close to each other.

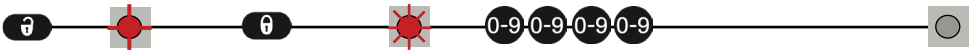

DELETING AN ACCESS CODE

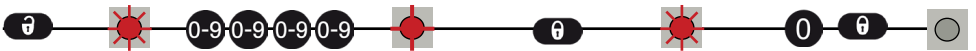

Enter the existing code

ADJUSTING ONE OR MORE PARAMETERS

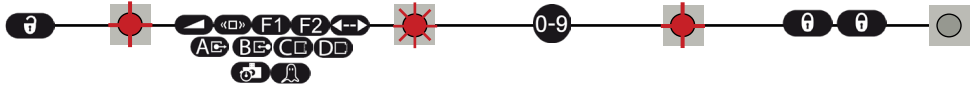

CHECKING A VALUE



x = number of flashes = value of the parameter

4x 1x 2x = field width: 4.2 m

3x = field width is defined by teach-in

RESTORING TO FACTORY VALUES

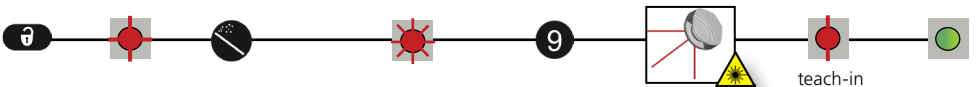

SAFETY FIELD TEACH-IN

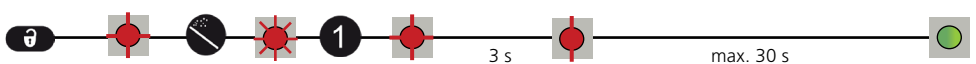

1 MOUNTING

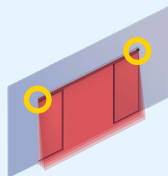

On sliding doors, the LZR should be installed on one of the two door frame corners.

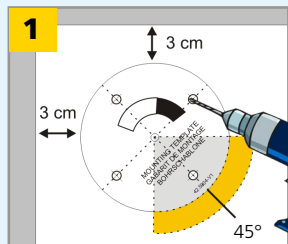

Use the mounting template to position the sensor correctly. The grey area indicates the detection range. Drill 4 holes and make a hole for the cable if possible.

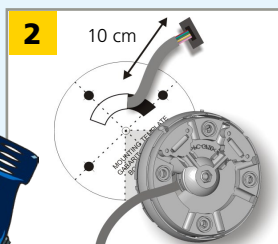

Pass the cable +/- 10 cm through the cable opening. If drilling an opening is not possible, use the cable conduits on the back side of the bracket.

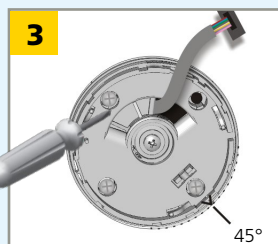

Position the bracket and fasten the 4 screws firmly in order to avoid vibrations.



Open the protection cover, plug the connector and position the cable in the slit. Close the protection cover and fasten it firmly.

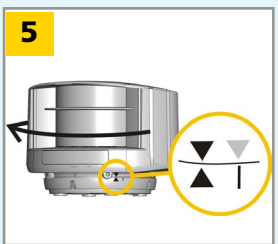

Position the housing on the bracket and turn the sensor until the two triangles are face to face.

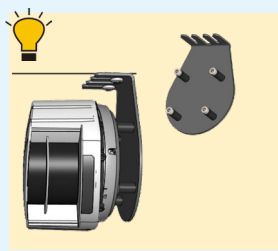

Use the LBA accessory if needed.

2 WIRING

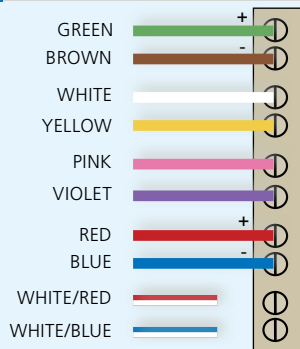

Use the Power Supply Module (24V DC, 0.75 A) if needed.



Door control without test: connect red and blue wires to power supply (no polarity)



3

POSITIONING

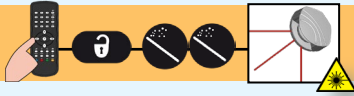

Unlock the sensor and activate the visible laser beams in order to position the curtains parallel to the door.



The visible laser beams indicate approximately the position of the curtain closest to the door. They stay activated for 15 minutes or can be turned off the same way they were activated.

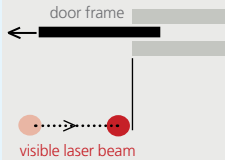
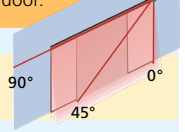

Adjust the **lateral position** of the detection field.

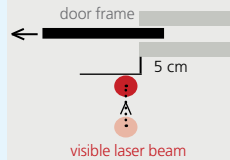
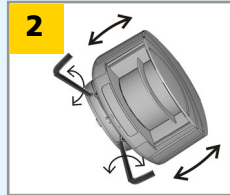

Adjust the **tilt angle** of the detection field with the hex key. The visible laser beam should be positioned 5 cm in front of the door frame.

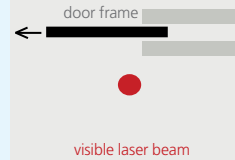
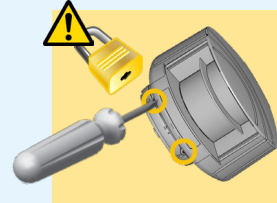

Lock the position of the mounting bracket to avoid malfunctioning in case of extreme vibrations.



Avoid reflections of the visible laser beams on the door frame.

4

MOUNTING SIDE

Check the mounting side and change the corresponding value if necessary.



Stay outside of the detection field to avoid disturbances.



WITH BACKGROUND

The sensor memorizes the floor as reference point and signals a fault when its orientation is changed.

WITHOUT BACKGROUND

No reference point

A teach-in is launched: the sensor learns its environment and automatically determines the detection field(s). Both RED LEDs flash slowly. The 3 visible laser beams automatically light up during the 30 seconds of the teach-in.

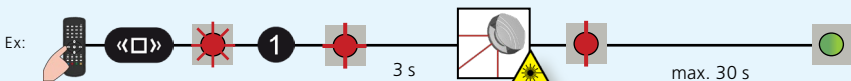

5

SAFETY FIELD CONFIGURATION

5.1 SAFETY FIELD TEACH-IN

Launch a teach-in after changing the sensor position or when new objects are added to or changed in the detection zone. The sensor will learn its surroundings and adapt the detection field shape to these. Objects in the detection field will be cut out.



During teach-in, the detection field should be free of snow buildups, heavy rain, snowfall, fog or other moving objects.

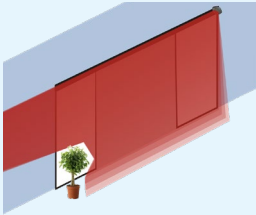
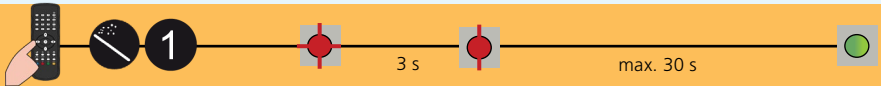

The door has to complete at least 1 full cycle (open + close) for the sensor to learn its environment. During this operation there is no safety on the door!

Once the door has completed its cycle, you can wait for the teach-in process to finish or lock the sensor by remote control:



5.2 FIELD WIDTH

After teach-in, the field width should be reduced by remote control.

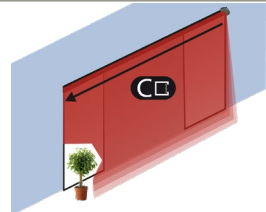
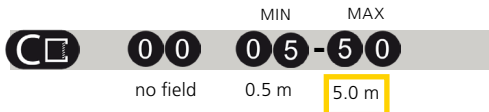

Ex:



for a field width of 4.2 m



The distance between the inner curtains of the 2 sensors must ensure the detection of the CA testbody (700 x 300 x 200 mm) according to EN 16005 and DIN 18650.

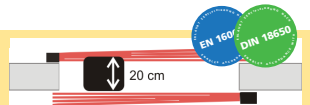

FACTORY VALUES



6 OPTIONAL CONFIGURATION

6.1 VIRTUAL PUSH BUTTON TEACH-IN (VPB)



Make sure the white and yellow wires are connected to the corresponding inputs before configuring the virtual push buttons.

Install 1 or 2 virtual push buttons to open the door «manually».

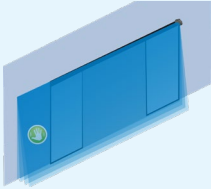

1 Apply the virtual push button sticker(s) **within** the optional field.

2 Launch a VPB teach-in to configure the detection zone(s). When the red LED flashes very slowly after 3 seconds, hold your hand in front of the sticker to learn the detection zone. The green LED flashes 3x to confirm the selection. When the red LED flashes again, learn a second (max. 2) detection zone or wait until the LED switches to green.

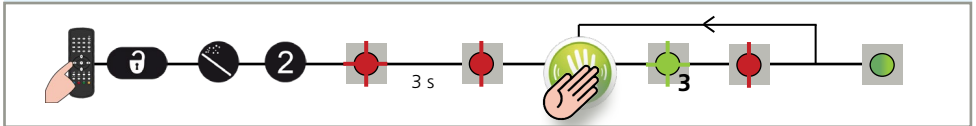

6.2 ACTIVATING/ DEACTIVATING THE DETECTION CURTAINS

Depending on the needed field depth, activate or deactivate the detection curtains.

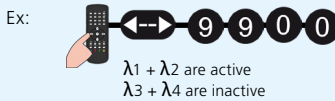
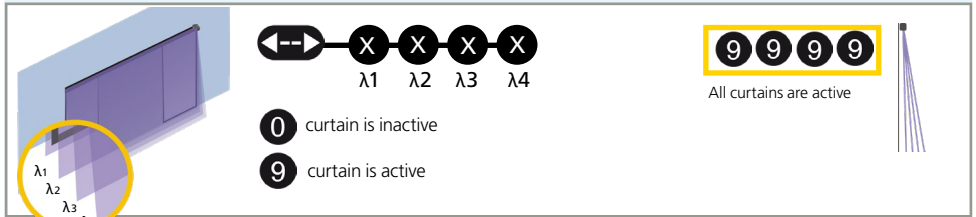

The distance between the curtains depends on the mounting height and side. When mounted on the left, the distance between λ_1 and λ_4 is approximately 10 cm for every meter (mounting height).

Example: at 5 m the distance between λ_1 and λ_4 is 50 cm.



Test the good functioning of the installation before leaving the premises.





1 MOUNTING

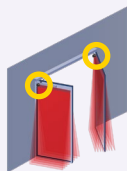

On swinging doors, the LZR should be installed in the upper corner of the door leaf. Make sure that the sensor does not touch the wall when the door is open.

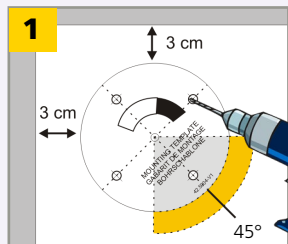

Use the mounting template to position the sensor correctly. The grey area indicates the detection range. Drill 4 holes and make a hole for the cable if possible.

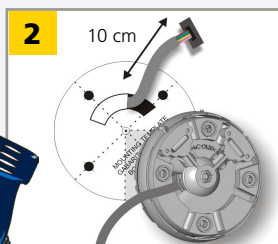

Pass the cable +/- 10 cm through the opening. If drilling an opening is not possible, use the cable conduits on the back side of the bracket.

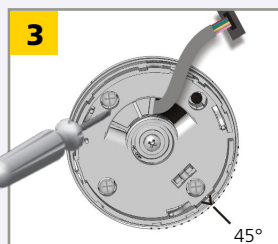

Position the bracket and fasten the 4 screws firmly in order to avoid vibrations.



Open the protection cover, plug the connector and position the cable in the slit. Close the protection cover and fasten it firmly.

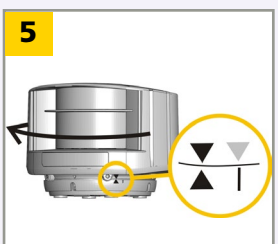

Position the housing on the bracket and turn the sensor until the two triangles are face to face.

LZR-P110 ON SWINGING DOORS

2 WIRING

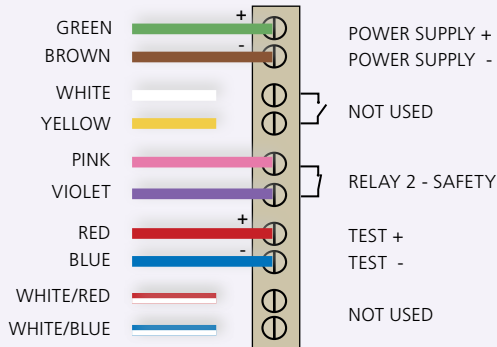

Use the Power Supply Module (24V DC, 0.75 A) if needed.



Door control without test: connect red and blue wires to power supply (no polarity)



3 POSITIONING

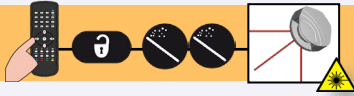

Unlock the sensor and activate the visible laser beams in order to position the curtains parallel to the door.



The visible laser beams indicate approximately the position of the curtain closest to the door. They stay activated for 15 minutes or can be turned off the same way they were activated.

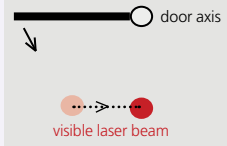
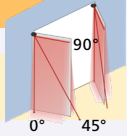

Adjust the **lateral position** of the detection field.

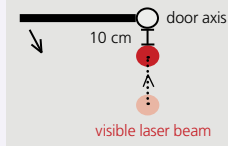
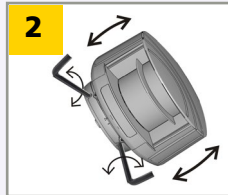

Adjust the **tilt angle** of the detection field with the hex key. The visible laser beam should be positioned 10 cm in front of the door axis.

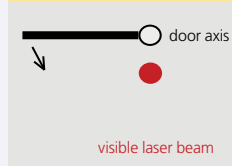
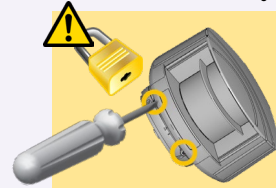

Lock the position of the mounting bracket to avoid malfunctioning in case of extreme vibrations.



Avoid reflections of the visible laser beams on the door wing.

4 MOUNTING SIDE

Check the mounting side and change the corresponding value if necessary.



Stay outside of the detection field to avoid disturbances.



1

left

2

right



3

left

4

right

5

centre



WITH BACKGROUND

The sensor memorizes the floor as reference point and signals a fault when its orientation is changed.

WITHOUT BACKGROUND

No reference point

A teach-in is launched: the sensor learns its environment and automatically determines the detection field(s). Both RED LEDs flash slowly. The 3 visible laser beams automatically light up during the 30 seconds of the teach-in.

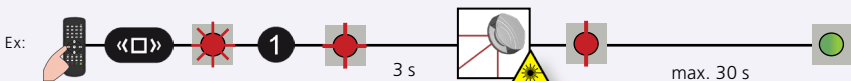

5

SAFETY FIELD CONFIGURATION

5.1 SAFETY FIELD TEACH-IN

Launch a teach-in after changing the sensor position or when new objects are added to or changed in the detection zone. The sensor will learn its surroundings and adapt the detection field shape to these. Objects in the detection field will be cut out.



During teach-in, the detection field should be free of snow buildups, heavy rain, snowfall, fog or other moving objects.

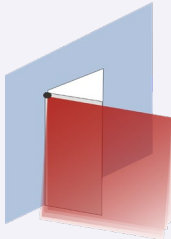
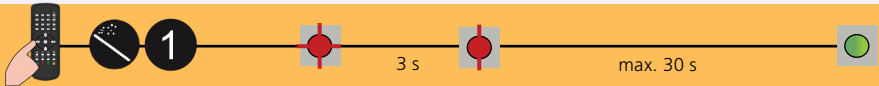

During this operation there is no safety on the door!

Wait for the teach-in process to finish or lock the sensor by remote control after min. 3 seconds:



5.2 FIELD WIDTH

After teach-in, the field width should be reduced by remote control.

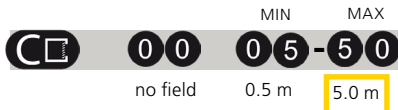

Ex:



for a field width of 4.2 m

FACTORY VALUES



6 OPTIONAL CONFIGURATION

6.1 ACTIVATING/ DEACTIVATING THE DETECTION CURTAINS

Depending on the needed field depth, activate or deactivate the detection curtains.

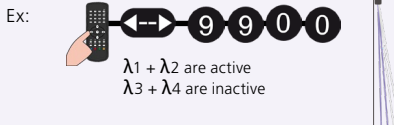
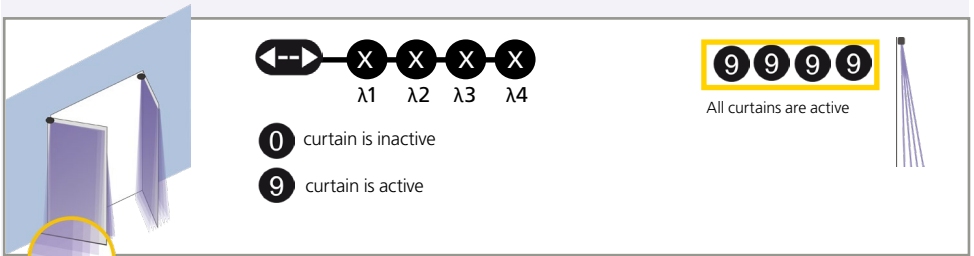

The distance between the curtains depends on the mounting height and side. When mounted on the left, the distance between $\lambda 1$ and $\lambda 4$ is approximately 10 cm for every meter (mounting height).
Example: at 5 m the distance between $\lambda 1$ and $\lambda 4$ is 50 cm.



Test the good functioning of the installation before leaving the premises.





1 MOUNTING



On revolving doors, the LZR should be installed in the upper corner of the door leaf.

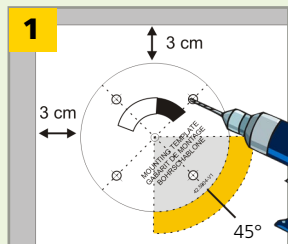

Use the mounting template to position the sensor correctly. The grey area indicates the detection range. Drill 4 holes and make a hole for the cable if possible.

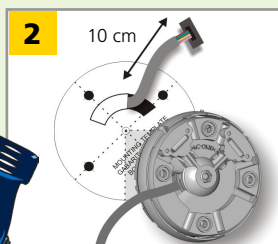

Pass the cable +/- 10 cm through the cable opening. If drilling an opening is not possible, use the cable conduits on the back side of the bracket.

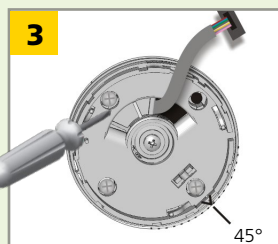

Position the bracket and fasten the 4 screws firmly in order to avoid vibrations.



Open the protection cover, plug the connector and position the cable in the slit. Close the protection cover and fasten it firmly.

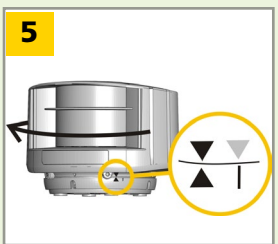

Position the housing on the bracket and turn the sensor until the two triangles are face to face.

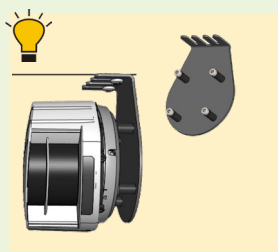

Use the LBA accessory if needed.

2 WIRING



Use the Power Supply Module (24V DC, 0.75 A) if needed.



Door control without test: connect red and blue wires to power supply (no polarity)



3 POSITIONING



Unlock the sensor and activate the visible laser beams in order to position the curtains parallel to the door.



The visible laser beams indicate approximately the position of the curtain closest to the door. They stay activated for 15 minutes or can be turned off the same way they were activated.

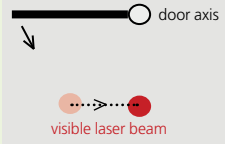
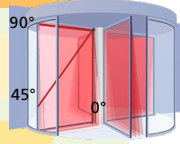

Adjust the **lateral position** of the detection field.

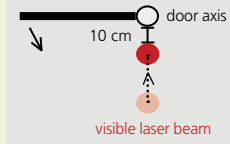
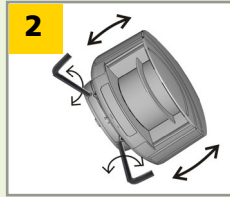

Adjust the **tilt angle** of the detection field with the hex key. The visible laser beam should be positioned 10 cm in front of the door axis.

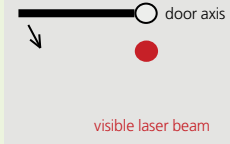
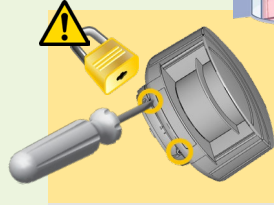

Lock the position of the mounting bracket to avoid malfunctioning in case of extreme vibrations.

Warning: Avoid reflections of the visible laser beams on the door wing.

4 MOUNTING SIDE

Check the mounting side and change the corresponding value if necessary.



Stay outside of the detection field to avoid disturbances.



1

left

2

right



3

left

4

right

5

centre



WITH BACKGROUND

The sensor memorizes the floor as reference point and signals a fault when its orientation is changed.

WITHOUT BACKGROUND

No reference point

A teach-in is launched: the sensor learns its environment and automatically determines the detection field(s). Both RED LEDs flash slowly. The 3 visible laser beams automatically light up during the 30 seconds of the teach-in.

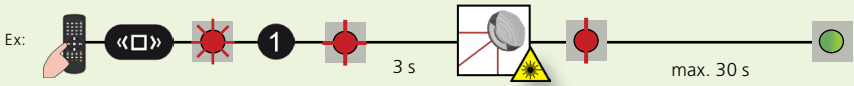

5 SAFETY FIELD CONFIGURATION

5.1 SAFETY FIELD TEACH-IN

Launch a teach-in after changing the sensor position or when new objects are added to or changed in the detection zone. The sensor will learn its surroundings and adapt the detection field shape to these. Objects in the detection field will be cut out.



During teach-in, the detection field should be free of snow buildups, fog or other moving objects.

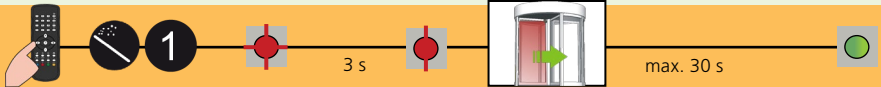

The door has to complete at least 1 full cycle (complete turn) for the sensor to learn its environment. During this operation there is no safety on the door!

Once the door has completed its cycle, you can wait for the teach-in process to finish or lock the sensor by remote control:



FACTORY VALUES

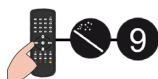

6 OPTIONAL CONFIGURATION (RELAY 1)

6.1 SLOW-DOWN FUNCTION

The optional field can be used to slow down the door.

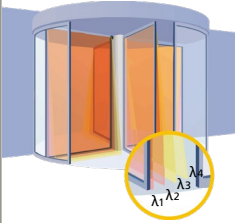





λ_1 λ_2 λ_3 λ_4

9 9 9 9



All curtains are active on both fields

- 0 curtain is inactive on both fields
- 1 curtain is active on optional field and slows down the door (R1)
- 2 curtain is active on safety field and stops the door (R2)
- 9 curtain is active on both fields

Ex:

$\lambda_1 + \lambda_2$ stop the door
 $\lambda_3 + \lambda_4$ slow down the door

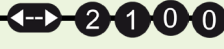
λ_1 stops the door
 λ_2 slows down the door
 $\lambda_3 + \lambda_4$ are inactive



The distance between the curtains depends on the mounting height and side. When mounted on the left, the distance between λ_1 and λ_4 is approximately 10 cm for every meter (mounting height).
Example: at 5 m the distance between λ_1 and λ_4 is 50 cm.



Test the good functioning of the installation before leaving the premises.

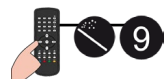

OTHER REMOTE CONTROL CONFIGURATIONS

FIELD DIMENSIONS

OPTIONAL



SAFETY



In order to configure the field dimensions of the optional field (relay 1), you have to cancel the virtual push button function by launching a new VPB teach-in without any movement in the detection field.

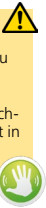

IMMUNITY FILTER

FOR CRITICAL ENVIRONMENTS (RAIN, SNOW, FOG)

FOR CRITICAL OBJECTS

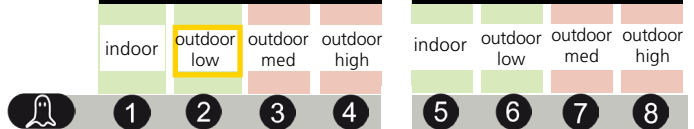

Choose between critical environments and critical objects.

UNCOVERED ZONE



Increase in case of snow, dead leaves, etc.

MIN. OBJECT SIZE (approximate values)



OUTPUT ACTIVATION DELAY (approximate values)

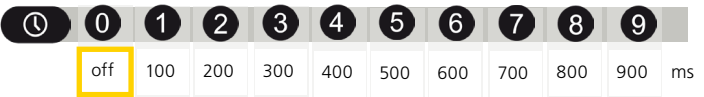

The relays are triggered if the detection duration \geq the selected time.
Values 1-9: test impact on the reaction time of the door system.

DETECTION FIELD REDIRECTION



OUTPUT CONFIGURATION

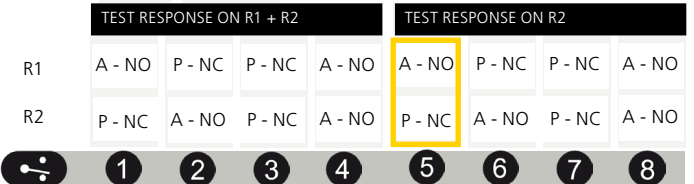
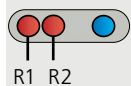

R1 = relay 1
R2 = relay 2

A = active
P = passive

NO = normally open
NC = normally closed



TROUBLESHOOTING

	No blue LED	<p>There is no power.</p> <p>The polarity of the power supply is inverted.</p> <p>All LEDs have been deactivated by remote control.</p>	<p>1 Check cable and connexion.</p> <p>1 Check the polarity of the power supply.</p> <p>1 Activate the LEDs by remote control.</p>
	Only the blue LED is on.	The test input is not connected.	<p>1 Check wiring. The RED and BLUE cable have to be connected to the test input or the power supply.</p>
	The detection LED remains green.	The detection field is too small or deactivated.	<p>1 Check the size of the fields.</p> <p>2 Launch a teach-in.</p>
	The detection LED remains red.	<p>The object size is too small.</p> <p>Someone or something is in the detection field.</p> <p>The field is touching the floor, the wall or the door, which leads to detection.</p>	<p>1 Decrease the min. object size.</p> <p>1 Step out of the field and/or remove the any object(s) from the field.</p> <p>1 Activate the 3 red beams and check if the position of the sensor is correct. If not, adjust the hex screws.</p> <p>2 Verify the field size.</p> <p>3 Launch a teach-in.</p>
	The orange LED is flashing and the detection LEDs are red.	No background (reference point) is found.	<p>1 Check the position of the sensor.</p> <p>2 Check the mounting side setting. If there is no background, set the mounting side to value 3 to 5.</p> <p>3 Launch a new teach-in.</p>
	The orange LED is on.	<p>The sensor is masked.</p> <p>The power supply voltage is exceeding the acceptable limits.</p> <p>The sensor exceeds its temperature limits.</p> <p>Internal error</p>	<p>1 Verify and clean the front screens with a damp cloth.</p> <p>1 Check the power supply voltage.</p> <p>1 Verify the outside temperature where the sensor is installed. Eventually protect the sensor from sunlight using a cover.</p> <p>1 Wait a few seconds. If the LED remains ON, reset the power supply. If the LED turns on again, replace the sensor.</p>
	The virtual push button does not work.	The position of the sensor has been changed.	<p>1 Check the position of the sensor.</p> <p>2 Launch a new VPB teach-in.</p>
	The sensor does not respond to the remote control.	<p>4 hours after last use of the remote control, the sensor locks the access to the remote control session.</p> <p>The batteries in the remote control are not installed properly or dead.</p> <p>The remote control is badly pointed.</p> <p>A reflective object is in close proximity to the sensor.</p>	<p>1 Cut and restore power supply. The remote control session is accessible again during 4 hours.</p> <p>1 Verify or replace the batteries.</p> <p>1 Point the remote control towards the sensor, but with a slight angle.</p> <p>1 Avoid highly reflective material in proximity to the sensor.</p>
	The sensor does not unlock.	You have to enter an access code or the wrong code was entered.	<p>1 Cut and restore power supply. No code is required to unlock during the first minute after powering.</p>

TECHNICAL SPECIFICATIONS

Technology:	laser scanner, time-of-flight measurement
Detection mode:	motion and presence
Max. detection range:	5.0 m x 5.0 m
Uncovered zone:	5 - 25 cm (adjustable)
Remission factor:	> 2 %
Angular resolution:	0.3516 °
Min. detected object size (typ.): (in proportion to object distance)	2.1 cm @ 3 m ; 3.5 cm @ 5 m
Testbody:	700 mm x 300 mm x 200 mm (testbody CA according to EN 16005/DIN 18650)
Emission characteristics:	(IEC/EN 60825-1)
IR laser:	wavelength 905 nm; output power <0.10 mW (CLASS 1)
Visible laser:	wavelength 635 nm; output power <1 mW (CLASS 2)
Supply voltage:	10-35 V DC @ sensor side (to be operated from SELV compatible power suppliers only)
Power consumption:	< 5 W
Peak current at power-on:	1.8 A (max. 80 ms @ 35 V)
Cable length:	5 m
Response time:	typ. 20 ms; max. 80 ms (+ output activation delay)
Output:	2 electronic relays (galvanic isolated - polarity free)
Max. switching voltage:	35 V DC / 24 V AC
Max. switching current:	80 mA (resistive)
Switching time:	t _{ON} =5 ms; t _{OFF} =5 ms
Output resistance:	typ 30 Ω
Voltage drop on output:	< 0.7 V @ 20 mA
Leakage current:	< 10 µA
Input:	2 optocouplers (galvanic isolated - polarity free)
Max. contact voltage:	30 V DC (over-voltage protected)
Voltage threshold:	Log. H: >8 V DC; Log. L: <3 V DC
Response time monitoring input:	< 5 ms
LED-signal:	1 blue LED: power-on status 1 orange LED: error status 2 bi-coloured LEDs: detection/output status (green: no detection; red: detection)
Dimensions:	125 mm (D) x 93 mm (W) x 70 mm (H) (mounting bracket + 14 mm)
Material:	PC/ASA
Colour:	black or white
Mounting angles on bracket:	-45 °, 0 °, 45 °
Rotation angles on bracket:	-5 ° to +5 ° (lockable)
Tilt angles on bracket:	-3 ° to +3 °
Protection degree:	IP65
Temperature range:	-30 °C to +60 °C if powered; -10 °C to +60 °C unpowered
Humidity:	0-95 % non-condensing
Vibrations:	< 2 G
Pollution on front screens:	max. 30 %; homogenous
Conformity:	EN 12978; EN ISO 13849-1 CAT2, Pl "d"; IEC 60825-1; IEC/EN 61496-1; IEC/EN 61496-3 ESPE Type 2; EN 62061 SIL 2; EN 16005 DIN 18650-1

PLEASE KEEP FOR FURTHER USE
DESIGNED FOR COLOUR PRINTING

©BEA | Original instructions | 42.7773 / V4 - 01.20



BEA SA | LIEGE SCIENCE PARK | ALLÉE DES NOISETIERS 5 - 4031 ANGLEUR [BELGIUM] | T +32 4 361 65 65 | F +32 4 361 28 58 | INFO@BEA.BE | WWW.BEA-SENSORS.COM



BEA hereby declares that the LZR®-P110 is in conformity with the European directives 2011/65/EU, 2014/30/EU and 2006/42/EC.

Notified Body for EC inspection: 0044 - TÜV NORD CERT GmbH, Langemarckstr. 20, 45141 D-Essen

EC-type examination certificate number: 44 205 13089626

Angleur, June 2018

Pierre Gardier

The complete declaration of conformity is available on our website

This product should be disposed of separately from unsorted municipal waste

