

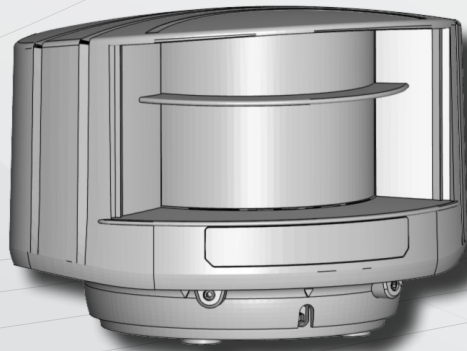

PLEASE KEEP FOR FURTHER USE  
DESIGNED FOR COLOUR PRINTING

EN



## LZR<sup>®</sup> -H100

### OPENING & SAFETY SENSOR FOR BARRIERS\*

\*Other applications of the device do not correspond to the intended purpose. The use on industrial doors is not permitted and infringe the patent EP 1 470 314 B1.

User's Guide for product version 0200 and higher  
See product label for serial number



## SAFETY



The device emits invisible IR and visible laser radiations.  
 IR laser: wavelength 905nm; output power 0.10mW  
 (Class 1 according to IEC 60825-1)  
 Visible laser: wavelength 635nm; output power 0.95mW  
 (Class 2 according to IEC 60825-1)

The visible laser beams are inactive during normal functioning. The installer can activate the visible lasers if needed. Do not stare into the visible red laser beams.



### CAUTION!

Use of controls, adjustments or performance of procedures other than those specified herein may result in hazardous radiation exposure.

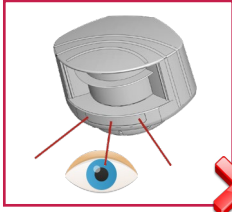

Do not look into the visible red laser beams.

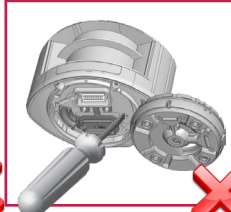

The warranty is void if unauthorized repairs are made or attempted by unauthorized personnel.



Only trained and qualified personnel may install and adjust the sensor.

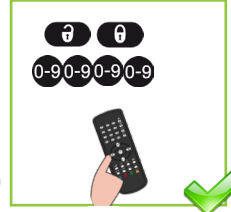

After installation, enter an access code by remote control.

This sensor is designed to be used as a movement and presence sensor to control the opening and the closing process of a gate or a portal. The manufacturer of the system is responsible for installing the sensor and the system in compliance with applicable national and international regulations and standards on safety. The manufacturer of the sensor cannot be held responsible for incorrect installations or inappropriate adjustments of the sensor.

## INSTALLATION & MAINTENANCE

**!** The presence of fog or smoke can cause the sensor to switch to detection to maintain the system's safety. This detection can therefore have consequences on the operation and availability of the system.

Make sure that such occasional behaviour is compatible with your installation/application.



Avoid extreme vibrations.

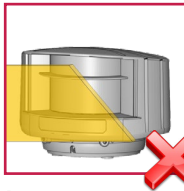

Do not cover the laser windows.

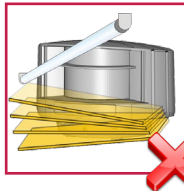

Avoid moving objects and light sources in front of the laser window.

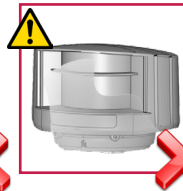

Avoid the presence of smoke and fog in the detection field.

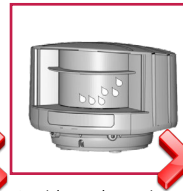

Avoid condensation on the laser windows.

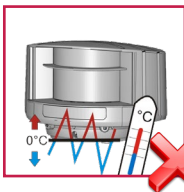

Avoid exposure to sudden and extreme temperature changes.

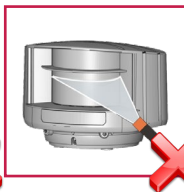

Avoid direct exposure to high pressure cleaning.



Do not use aggressive products to clean the laser windows.



Clean the laser window with compressed air. If needed, wipe only with a soft, clean and damp microfibre cloth.

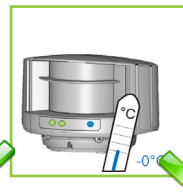

Keep the sensor permanently powered in environments where the temperature can descend below 0°C.

## DESCRIPTION

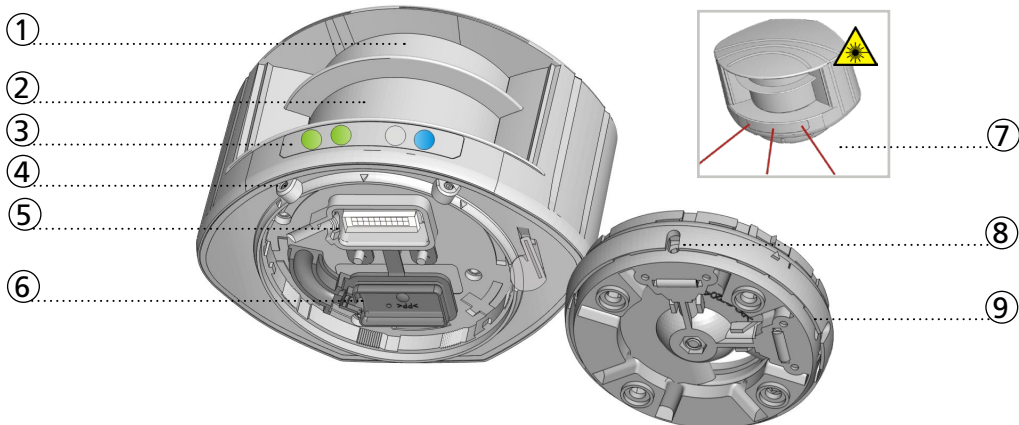

1. laser window - emission
2. laser window - reception
3. LED-signal
4. screws for position lock
5. connector
6. protection cover

7. visible laser beams
8. notch for tilt angle adjustment
9. adjustable bracket

## LED-SIGNALS

R1	R2	E	P	R1: Relay 1 - detection in opening field		detection		no detection
				R2: Relay 2 - detection in safety field		error		no error
LED-signal at power-on				E: Error status		power		no power
				P: Power status				

	LED is on		LED flashes		LED flashes quickly		LED is off
--	-----------	--	-------------	--	---------------------	--	------------

All 4 LEDs can be switched off and on again by remote control. This can be useful in cases where the sensor should not draw any attention.



## SYMBOLS

Caution!  
Laser radiation

Important

Good to know

Important remote control sequence

Possible remote control adjustments

Factory values

## BASIC PRINCIPLES

It is important to understand some basic principles before installing the sensor.

### VISIBLE RED LASER BEAMS

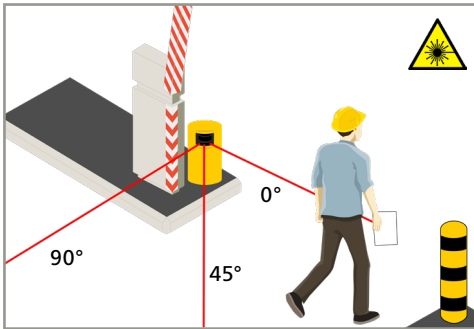

The sensor and detection field position are very important for the good functioning of the barrier.

In order to position the sensor correctly, it is possible to use a visual aid. 3 visible red laser beams can be activated by remote control:



The visible laser beams are also used to determine the reference of the sensor in order to ensure the safety of the barrier.

### REFERENCE

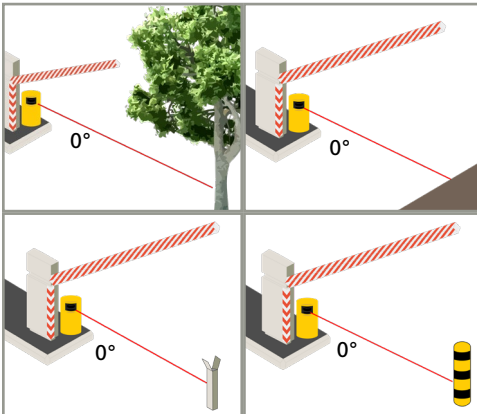

The sensor has to learn a reference when the safety field is the only protection against contact between the vehicle and the boom.

The reference can be adjusted on any type of object already present on site (wall, tree, barrier boom support) or on a post.

Always make sure the object on which the reference is adjusted:

- is positioned in the continuity of the 0° laser beam
- is positioned min. at the end of the boom or farther away than the end of the boom
- has a surface of +/- 10 cm (min. 5 cm)
- is firmly fixed to the floor and not subject to vibrations

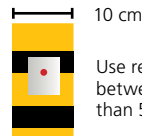

Use reflective sticker when the distance between sensor and reference is higher than 5 m.

### SAFETY FIELD

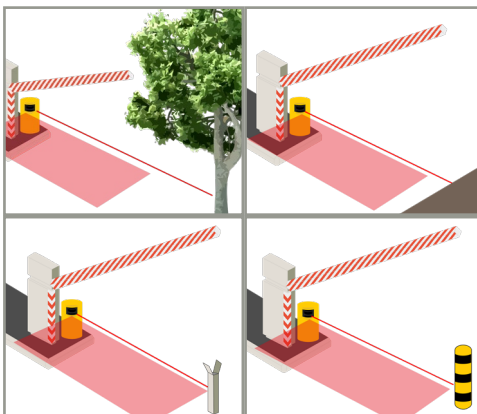

If the safety field is the only protection against contact with the boom, the safety field of the sensor must be situated right under the boom.

This is only possible when the sensor is positioned correctly and the reference has been learned.

If the reference is situated at the end of the boom, the detection field width is the same as the reference distance. If the reference is farther away, you need to adjust the detection field width to the width of the boom.

In order to maximise safety in case of mixed traffic (vehicles and trucks), an additional vertical detection zone is recommended (LZR-I100).

## APPLICATION REQUIREMENTS

Below you can find our requirements to assure optimal safety of the barrier in order to protect against contact with the boom.

### DOUBLE ACCESS LANE

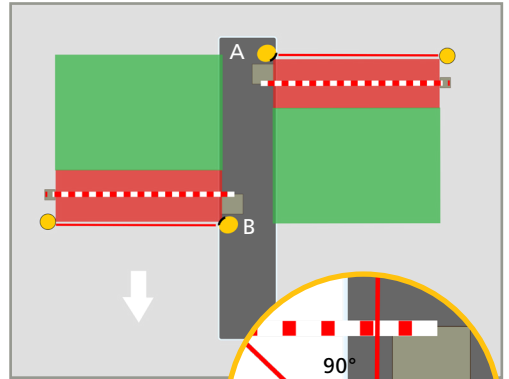
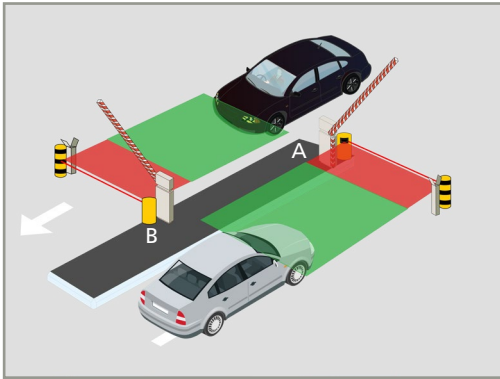

- 2 LZR-H100
- 2 references, 1 for each sensor

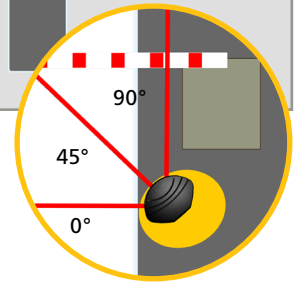

### SINGLE ACCESS LANE

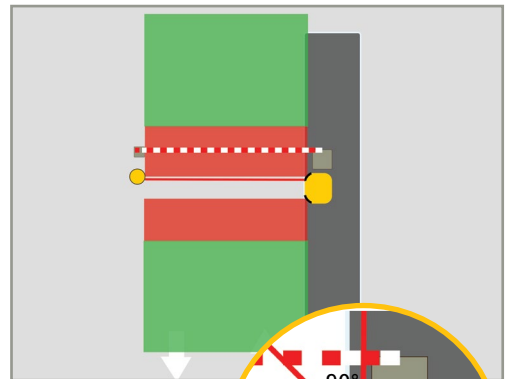
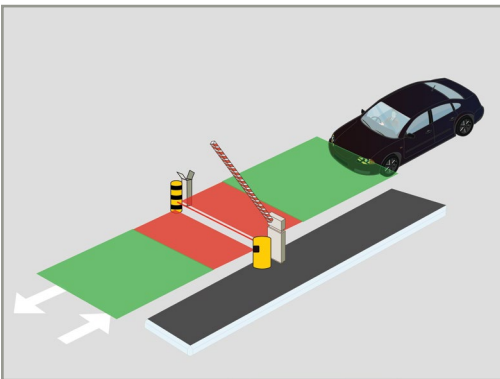

- 2 LZR-H100
- 1 reference

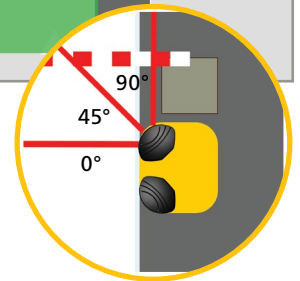

 SAFETY FIELD

 OPENING FIELD



To optimize detection for high vehicles like trucks, add a vertical safety field just before the barrier (LZR-I100).

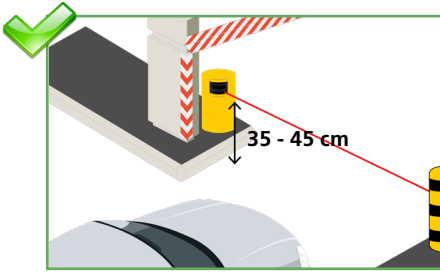

Install the sensor at a mounting height of 35 - 45 cm. If the barrier is only used by trucks, the mounting height can be increased.

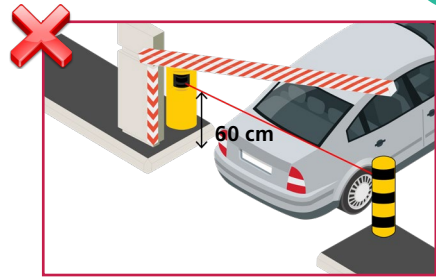

If the reference beam is too low or too high, contact with the boom cannot be excluded.

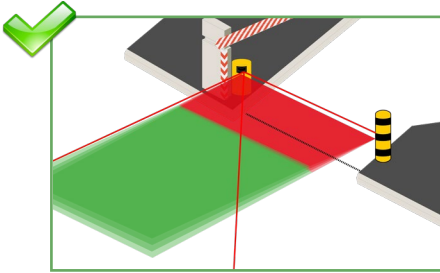

Make sure to place the detection field parallel to the boom.

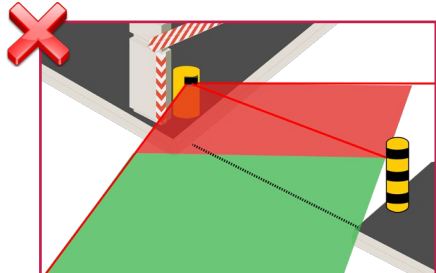

Do not position the detection field as shown.

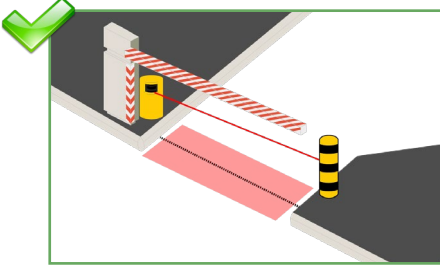

When using the safety, place the sensor just behind the barrier. This way the safety field protects the area around the boom.

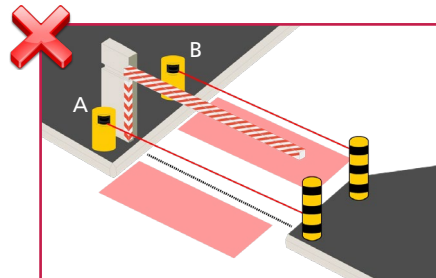

When using the safety, do not place the sensor before the barrier (A) or more than 40 cm after the boom (B). The area around the boom is not safe.

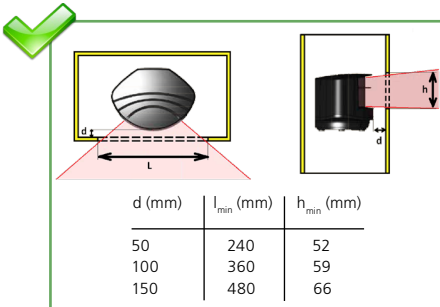

Keep the front face of the sensor free!

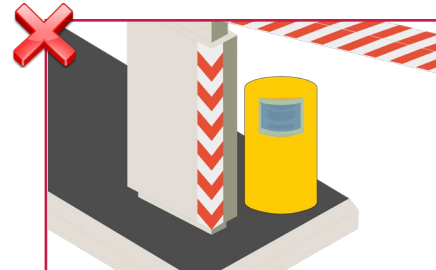

Do not cover the front face of the sensor with glass or plastic.

# 1 MOUNTING & WIRING



Carefully read the application requirements and tips before mounting the sensor.  
The mounting position of the sensor is crucial for the good functioning of the barrier.

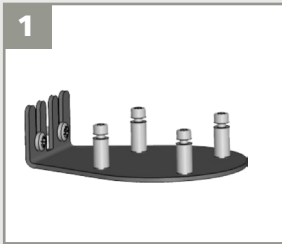

1 Use a mounting post or a mounting bracket to fix the sensor on the pole.

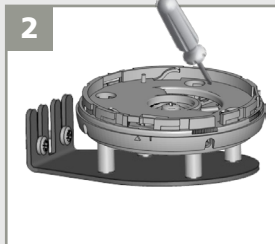

2 Position the mounting bracket and fasten the 4 screws firmly in order to avoid vibrations.



3 Open the protection cover, plug the connector and position the cable in the slit.



4 Close the protection cover and fasten it firmly.

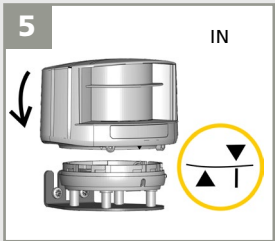

5 Position the housing on the mounting base.

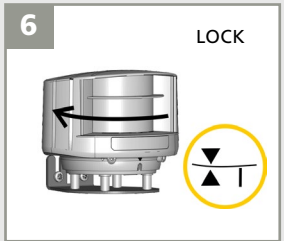

6 Turn the sensor until the two triangles are face to face.

GREEN +		POWER SUPPLY + POWER SUPPLY -	Make sure you don't confuse the white wire with the striped wires (not used)
BROWN -			
WHITE		RELAY 1 - OPENING FIELD	
YELLOW			
PINK		RELAY 2 - SAFETY FIELD	
VIOLET			
RED +		TEST + TEST -	No test function: connect RED/GREEN and BLUE/BROWN to power supply. Polarity is important.
BLUE -			
WHITE/RED		NOT USED	
WHITE/BLUE			



LED-signal at power-on: correct positioning is needed



Power on without test signal: connect red + blue to test or power supply.



No detection



Safety & opening detection



## 2 FIELD POSITIONING

 The detection field and reference position are very important for the good functioning of the barrier.

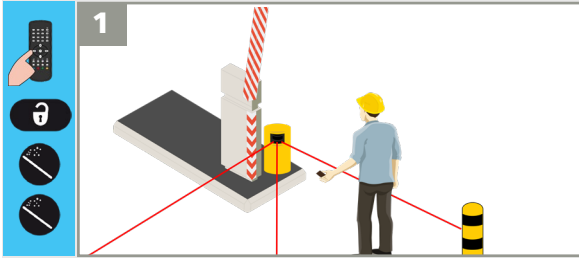

1 Activate the visible laser beams by remote control to position the sensor correctly.

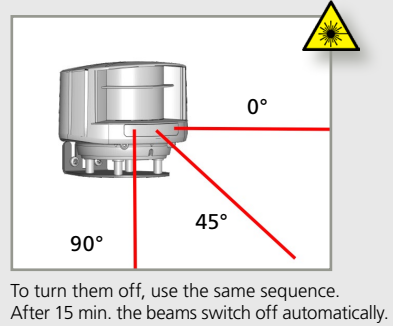

To turn them off, use the same sequence. After 15 min. the beams switch off automatically.

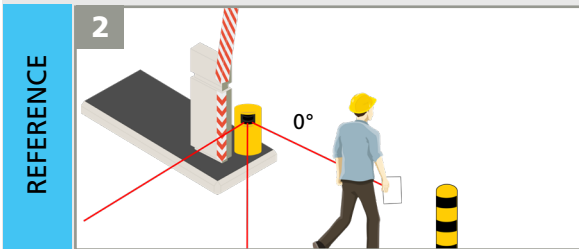

2 Use a white paper to verify the position of the 0° laser beam. The reference point can be adjusted on any object at the end of the boom or farther away. Its surface should be +/- 10 cm and it must be firmly fixed. Use the reflective sticker when the distance between sensor and reference is higher than 5 m (see p. 4)

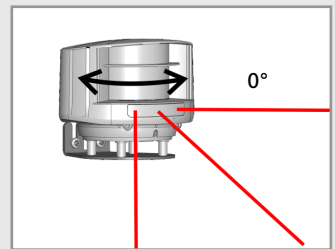

Turn the sensor slightly on its axis to adjust the lateral angle of the sensor to place the 0° laser spot on the reference.

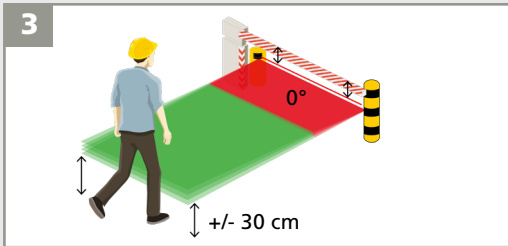

- The 0° spot must be parallel to the boom.
- The beginning of the opening field should be at midcalf height.

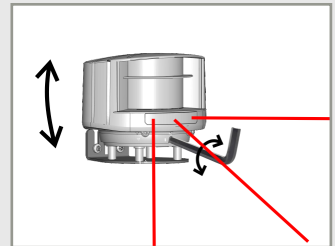

Adjust the tilt angle of the detection field with the hex key if necessary.



4 To finish, lock the sensor position by using a PH1 screwdriver.

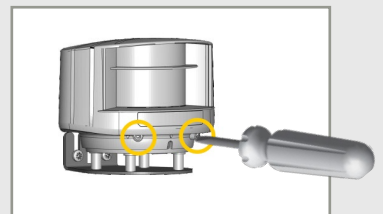



### 3 MOUNTING SIDE & REFERENCE

Select the correct mounting side with or without reference.

#### WITH REFERENCE (RECOMMENDED)



The safety field secures the area around the boom and protects against contact with the boom in accordance with EN 12453 - safety device E.

#### WITHOUT REFERENCE



The safety field detects the presence of a car, but the area around the boom is not secured according to EN 12453. Contact with the boom can not be excluded!

MOUNTED ON YOUR LEFT

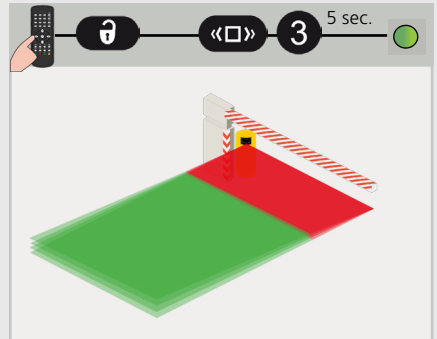
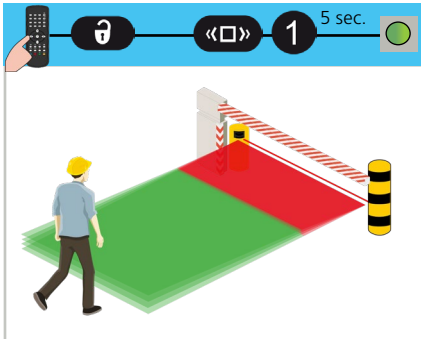

MOUNTED ON YOUR RIGHT

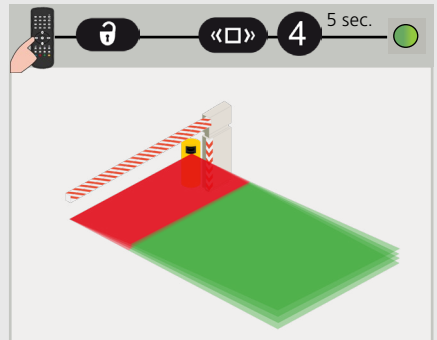
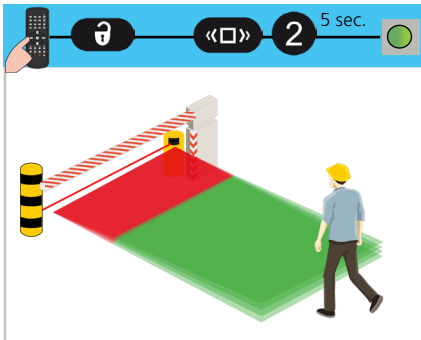

By default, the sensor automatically adjusts the width of the safety field based on the reference.

Select a mounting side with reference or install a complementary safety device.

## 4 SAFETY FIELD

### 1 FIELD DIMENSIONS

Before launching a teach-in, the field dimensions can be adjusted by remote control.

Value C must be adapted to the width of the boom:

- when the reference point is farther away than the desired detection field width
- when a mounting side **without reference** has been selected

WIDTH

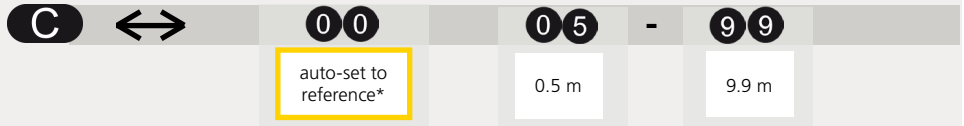

\* without reference, the width will be automatically set to 9.9 m

DEPTH

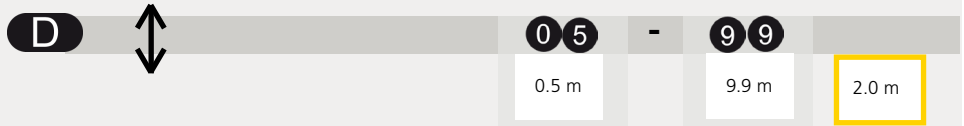

EX:      for a field depth of 1.5 m

You can also increase or decrease the field by 10 cm:



### 2 TEACH-IN

Launch a teach-in by remote control. You have 3 seconds to step out of the detection field. Then wait for the sensor to learn its environment (30 seconds).

During the teach-in, the detection field must be free of snow buildups, heavy rain, snowfall, fog or other moving objects.

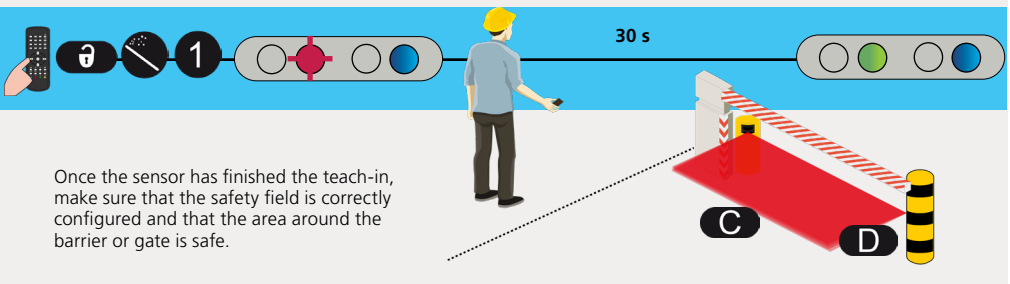

Once the sensor has finished the teach-in, make sure that the safety field is correctly configured and that the area around the barrier or gate is safe.



Always launch a new teach-in after adjusting the field dimensions.

If the safety field is the only protection against contact with the boom, the safety field of the sensor must be situated right under the boom. This is only possible when the sensor is positioned correctly and the reference has been learned.

The safety field is necessary for the correct functioning of the installation. If the safety field is badly adjusted, the manufacturer of the sensor cannot be held responsible for inappropriate functioning of the installation. Always verify the correct functioning of the safety field before leaving the premises.

## 5 OPENING FIELD

### 1 FIELD DIMENSIONS

Before launching a teach-in, the field dimensions can be adjusted by remote control.

WIDTH

<b>A</b> ↔	00	MIN 05	-	MAX 99
	same width as safety field	0.5 m		9.9 m

DEPTH

<b>B</b> ↔	00	05	-	99
	if no opening field is needed	0.5 m		9.9 m

EX:   **B** **50** for a field depth of 5 m

You can also increase or decrease the field by 10 cm:



### 2 TEACH-IN

Launch a teach-in by remote control. You have 3 seconds to step out of the detection field. Then wait for the sensor to learn its environment (45 seconds).

During the teach-in, the detection field must be free of snow buildups, heavy rain, snowfall, fog or other moving objects.

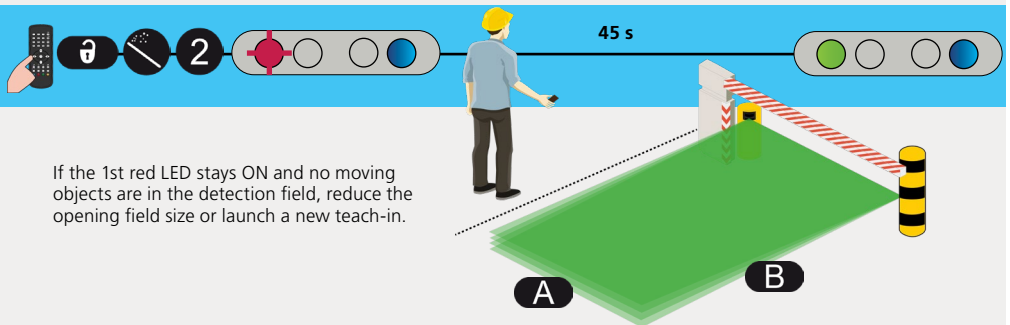

If the 1st red LED stays ON and no moving objects are in the detection field, reduce the opening field size or launch a new teach-in.



Always launch a new teach-in after adjusting the field dimensions.

## REMOTE CONTROL ADJUSTMENTS (OPTIONAL)

### PEDESTRIAN FILTER

opening field

Select value 3 or higher to reject pedestrians. All objects wider than the chosen will be detected.

	1	2	3	4	5	6	
	off	50	65	72	100	120	cm

approximate values

### MAX. PRESENCE TIME

opening field

STANDSTILL IN OPENING FIELD: select the amount of time relay 1 should stay active in case a car stops in the opening field.

	0	1	2	3	4	5	6	7	8	9
	off	5 s	10 s	30 s	1 min	2 min	5 min	10 min	2 h	infinite

### DETECTION DELAY

opening field

ENVIRONMENT FILTER: increase value in case of heavy rain, snow or moving objects in the environment.

	0	1	2	3	4	5	6	7	8	9	
	off	100	200	300	400	500	600	700	800	900	ms

approximate values

### OUTPUT FUNCTION

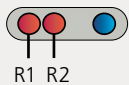

<b>F1</b>	0	1	2
RELAY 1	motion	motion or presence	motion + presence
RELAY 2	presence	presence	presence

### OUTPUT CONFIGURATION

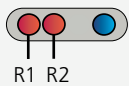

	1	2	3	4
RELAY 1	NO	NC	NC	NO
RELAY 2	NC	NO	NC	NO

FACTORY VALUE

## REMOTE CONTROL ADJUSTMENTS (OPTIONAL)

### DETECTION TRAJECTORY

opening field

			1	2	3	4	5	6	7	8
BIDIRECTIONAL	bidirectional detection approaching + going away									1
UNI 400%	unidirectional detection only approaching in any direction									2
UNI 200%	unidirectional detection only approaching towards the barrier/gate									3
UNI 100%	unidirectional detection only approaching within width of barrier/ gate									4
UNI 50%	unidirectional detection only approaching towards central zone of barrier/gate									5
UNI CENTRE	unidirectional detection only approaching towards centre of bar- rier/gate									6
UNI RIGHT	unidirectional detection only approaching towards right side									7
UNI LEFT	unidirectional detection only approaching towards left side									8

### IMMUNITY

	1	2	
	standard	high	select high if fog is causing unwanted detections

### MAGIC WAND

	1	2	9	
	teach-in safety field	teach-in opening field	factory values	visible laser beams

# HOW TO USE THE REMOTE CONTROL



After unlocking, the first LED flashes red and the sensor can be adjusted by remote control.



If the red LED flashes quickly after unlocking, you need to enter an access code from 1 to 4 digits.



To end an adjustment session, always lock the sensor.

## ADJUSTING ONE OR MORE PARAMETERS

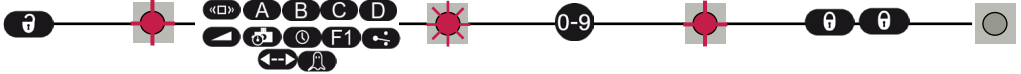

## CHECKING A VALUE

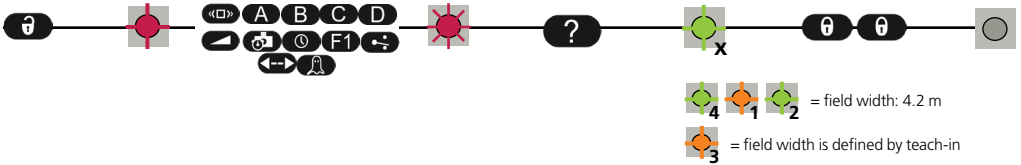

## RESTORING TO FACTORY VALUES

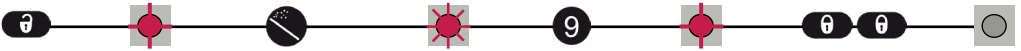

## SAVING AN ACCESS CODE

The access code is recommended for sensors installed close to each other.

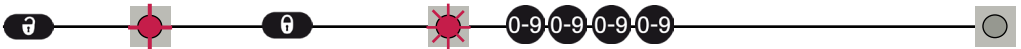











## DELETING AN ACCESS CODE



X = NUMBER OF FLASHES = VALUE OF THE PARAMETER

## TROUBLESHOOTING

	No blue LED	There is no power.	<b>1</b> Check cable and connexion.
		The polarity of the power supply is inverted.	<b>1</b> Check the polarity of the power supply.
		All LEDs have been deactivated by remote control.	<b>1</b> Activate the LEDs by remote control:   <b>4</b>
	Only blue LED	Power on without test signal	<b>1</b> Connect red and blue wires to test entrance or power supply.
	The detection LED remains green.	The detection field is too small or deactivated.	<b>1</b> Check the size of the fields. <b>2</b> Launch a teach-in.
		The object size is too small.	<b>1</b> Decrease the min. object size.
	The detection LED remains red.	Someone or something is in the detection field.	<b>1</b> Step out of the field and/or remove the any object(s) from the field.
		The field is touching the floor, the wall or the barrier, which leads to detection.	<b>1</b> Activate the 3 red beams and check if the position of the sensor is correct. If not, adjust the hex screws. <b>2</b> Verify the field size. <b>3</b> Launch a teach-in.
 	The orange LED is flashing and the detection LEDs are red.	No reference point is found.	<b>1</b> Check the position of the sensor. <b>2</b> Check the position of the 0° red laser beam. <b>3</b> Check the size of and distance to the reference point and add a reflective sticker if needed. <b>4</b> Check the mounting side setting. If no reference is needed, set the mounting side to value 3 or 4. <b>5</b> Launch a new teach-in.
		The sensor is masked.	<b>1</b> Verify and clean the front screens with a damp cloth.
	The orange LED is on.	The power supply voltage is exceeding the acceptable limits.	<b>1</b> Check the power supply voltage.
		The sensor exceeds its temperature limits.	<b>1</b> Verify the outside temperature where the sensor is installed. Eventually protect the sensor from sunlight using a cover.
		Internal error	<b>1</b> Wait a few seconds. If the LED remains ON, reset the power supply. If the LED turns on again, replace the sensor.
	The sensor does not respond to the remote control.	The batteries in the remote control are not installed properly or dead.	<b>1</b> Verify or replace the batteries.
		The remote control is badly pointed.	<b>1</b> Point the remote control towards the sensor, but with a slight angle. The RC should not be pointed in a right angle in front of the sensor.
		A reflective object is in close proximity to the sensor.	<b>1</b> Avoid highly reflective material in proximity to the sensor.
	The sensor does not unlock.	You have to enter an access code or the wrong code was entered.	<b>1</b> Cut and restore power supply. No code is required to unlock during the first minute after powering. Delete or change code.

## TECHNICAL SPECIFICATIONS

<b>Technology</b>	LASER scanner, time-of-flight measurement (4 laser curtains)
<b>Detection mode</b>	Motion and presence
<b>Max. detection field</b>	9.9 m x 9.9 m
<b>Remission factor</b>	> 2 %
<b>Angular resolution</b>	0,3516 °
<b>Emission characteristics</b> (IEC/EN 60825-1)	IR LASER: Wavelength 905 nm; output power 0.10mW; Class 1 Visible LASER: Wavelength 635 nm; output power 0.95mW; Class 2
<b>Supply voltage</b>	10-35 V DC @ sensor side (to be operated from SELV compatible power supplies only)
<b>Power consumption</b>	< 5 W
<b>Peak current at power-on:</b>	1,8 A (max. 80 ms @ 35 V)
<b>Cable length:</b>	5 m (standard), max.: 10 m
<b>Response time</b>	
Motion detection:	typ. 200 ms (adjustable)
Presence detection:	typ. 20 ms; max. 80 ms
<b>Output:</b>	2 electronic relays (galvanic isolated - polarity free)
Max. switching voltage:	35 V DC / 24 V AC
Max. switching current:	80 mA (resistive)
Switching time:	$t_{ON}=5$ ms; $t_{OFF}=5$ ms
Output resistance:	typ 30 $\Omega$
Voltage drop on output:	< 0.7 V @ 20 mA
Leakage current:	< 10 $\mu$ A
<b>Test input:</b>	1 optocoupler (galvanic isolated - polarity free)
Max. contact voltage:	30 V DC (over-voltage protected)
Voltage threshold:	Log. H: >8 V DC; Log. L: <3 V DC
<b>LED-signal:</b>	1 blue LED: power-on status; 1 orange LED: error status; 2 bi-coloured LEDs: detection/output status (green: no detection; red: detection)
<b>Dimensions:</b>	125 mm (D) x 93 mm (W) x 70 mm (H) (with mounting bracket + 14 mm)
<b>Material / Colour:</b>	PC/ASA / black
<b>Mounting angles on bracket:</b>	-45 °, 0 °, 45 °
<b>Rotation angles on bracket:</b>	-5 ° to +5 ° (lockable)
<b>Tilt angles on bracket:</b>	-3 ° to +3 °
<b>Protection degree:</b>	IP65
<b>Temperature range:</b>	-30 °C to +60 °C if powered; -10 °C to +60 °C unpowered
<b>Humidity:</b>	0-95 % non-condensing
<b>Vibrations:</b>	< 2 G
<b>Pollution on front screens:</b>	max. 30 %; homogenous
<b>Conformity:</b>	EN 60825-1; EN 12453 (Device E) EN ISO 13849-1 (PI "d" CAT 2); EN 62061 (SIL 2); EN 61496-1; EN 61496-3 (Type 2); EN 12978

*Specifications are subject to change without prior notice - All values measured in specific conditions.*



BEA hereby declares that the LZR<sup>®</sup>-H100 is in conformity with the European directives 2014/30/EU, 2006/42/EC, 2011/65/EU.

Notified body for EC inspection: 0044, TÜV NORD CERT GmbH, Langemarkstr. 20, 45141 Essen

EC-type examination No.: 44 780 13 089628

Angleur, 01/2018 Pierre Gardier

The complete declaration of conformity is available on our website.

This product should be disposed of separately from unsorted municipal waste

