

# IXIO-D CAN

## OPENING & SAFETY SENSOR FOR AUTOMATIC SLIDING DOORS

(according to EN 16005 and DIN 18650,  
including emergency exits)

User's Guide for software version 0204 and higher  
(refer to tracking label on product)

### DESCRIPTION

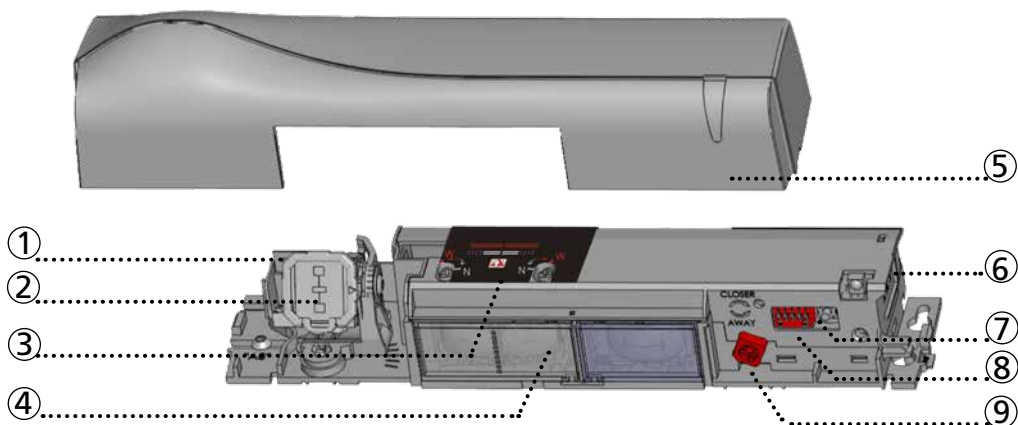

- |    |                              |    |                                  |
|----|------------------------------|----|----------------------------------|
| 1. | radar antenna (narrow field) | 6. | main connectors                  |
| 2. | radar antenna (wide field)   | 7. | push button                      |
| 3. | IR-curtain width adjustment  | 8. | DIP-switch                       |
| 4. | IR-lenses                    | 9. | IR-curtain angle adjustment knob |
| 5. | cover                        |    |                                  |

### ACCESSORIES



BA: Bracket accessory



CA: Ceiling accessory



RA: Rain accessory



BEA Remote control



CDA: Curved door  
accessory

## LED-SIGNAL

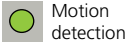

Motion detection

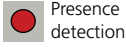

Presence detection

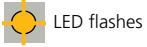

LED flashes

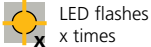

LED flashes  
x times

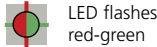

LED flashes  
red-green

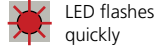

LED flashes  
quickly



LED is off

## INSTALLATION



The sensor should be fixed firmly to avoid extreme vibrations.



Do not cover the sensor.



Avoid moving objects and light sources in the detection field.



Avoid highly reflective objects in the infrared field.

## MAINTENANCE



It is recommended to clean the optical parts at least once a year or more if required due to environmental conditions.



Do not use aggressive products to clean the optical parts.

## SAFETY

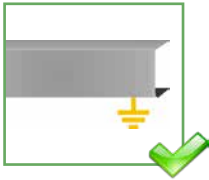

The door control unit and the door cover profile must be correctly earthed.



Only trained and qualified personnel may install and setup the sensor.



Always test the good functioning of the installation before leaving the premises.

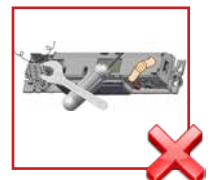

The warranty is invalid if unauthorized repairs are made or attempted by unauthorized personnel.





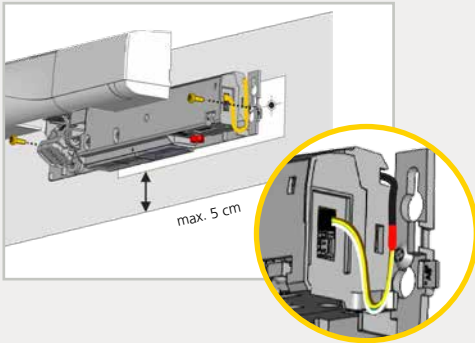

- The device cannot be used for purposes other than its intended use. All other uses cannot be guaranteed by the manufacturer of the sensor.
- The manufacturer of the door system is responsible for carrying out a risk assessment and installing the sensor and the door system in compliance with applicable national and international regulations and standards on door safety.
- The manufacturer of the sensor cannot be held responsible for incorrect installations or inappropriate adjustments of the sensor.

# IXIO-D CAN: INSTALLATION GUIDE

## 1 MOUNTING & WIRING



GREEN		+	POWER SUPPLY
BROWN		-	
YELLOW			CAN HIGH
WHITE			CAN LOW



Plug the connector with the WHITE and GREEN wires on top towards the sensor cover.

## 2 RADAR OPENING IMPULSE FIELD

ANGLE

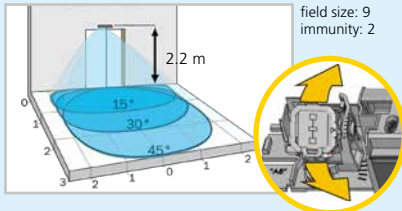

from 15° to 45°, default 30°

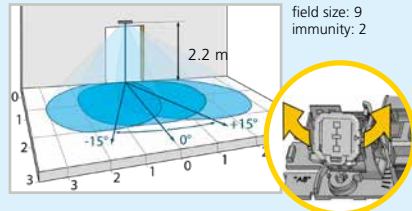

from -15° to 15°, default 0°

WIDTH

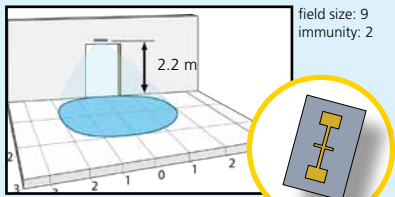

4 m x 2 m (wide)

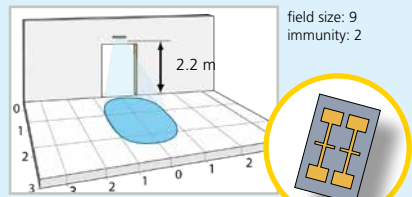

2 m x 2.5 m (narrow)

The size of the detection field varies according to the mounting height of the sensor. In emergency exits the full door width must be covered.

### 3 INFRARED SAFETY FIELD

ANGLE

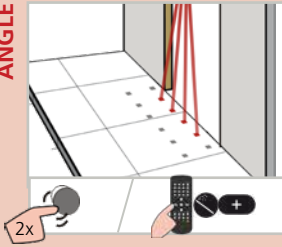

Activate the visible\* spots to verify the position of the IR-curtain.

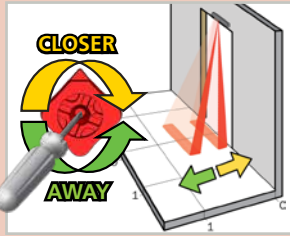

If necessary, adjust the IR-curtain angle (from  $-7^\circ$  to  $4^\circ$ , default  $0^\circ$ ).

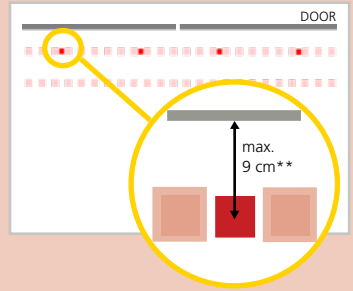

\* Visibility depends on external conditions. When spots are not visible, use the Spotfinder to locate the curtains.  
 \*\* The distance between the inner curtain of the inside door sensor and the inner curtain of the outside door sensor should always be smaller than 20 cm. The distance to the door leaf depends therefore on the thickness of the door leaf.

WIDTH

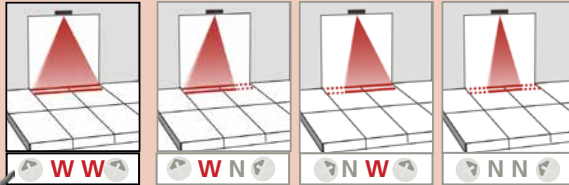

Part of the detection field can be masked to reduce it. The arrow position determines the width of the detection field.

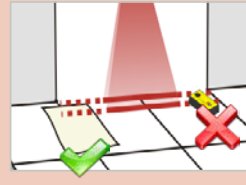

**TIP!**  
 Additional adjustments are possible (see p. 6)

Always verify the actual detection field width with a piece of paper and not the Spotfinder, which detects the whole emitted field.

Mounting height	Detection width
2.00 m	2.00 m
2.20 m	2.20 m
2.50 m	2.50 m
3.00 m	d max
3.50 m	d max

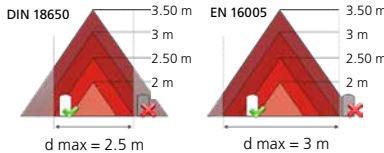

The size of the detection field varies according to the mounting height and the settings of the sensor. The full door width must be covered.

### 4 DIP-SWITCH 1-4: CAN-ADDRESS



DIP-switches: each sensor needs a different CAN address depending on its position.

After changing a DIP-switch, the orange LED flashes quickly. Cut and restore power supply to confirm the setting.

<p>SENSOR 1</p> <p>address 0</p>	<p>SENSOR 2</p> <p>address 1</p>	<p>SENSOR 3</p> <p>address 2</p>	<p>SENSOR 4</p> <p>address 3</p>	<p>SENSOR 5</p> <p>address 4</p>	<p>SENSOR 6</p> <p>address 5</p>	<p>SENSOR 7</p> <p>address 6</p>	<p>SENSOR 8</p> <p>address 7</p>
<p>SENSOR 9</p> <p>address 8</p>	<p>SENSOR 10</p> <p>address 9</p>	<p>SENSOR 11</p> <p>address 10</p>	<p>SENSOR 12</p> <p>address 11</p>	<p>SENSOR 13</p> <p>address 12</p>	<p>SENSOR 14</p> <p>address 13</p>	<p>SENSOR 15</p> <p>address 14</p>	<p>SENSOR 16</p> <p>address 15</p>

## 5 DIP-SWITCH 5: POSITION IN CHAIN

On the last sensor of the chain, adjust DIP-switch 5 to ON.  
The orange LED next to the DIP-switch will be permanently on.

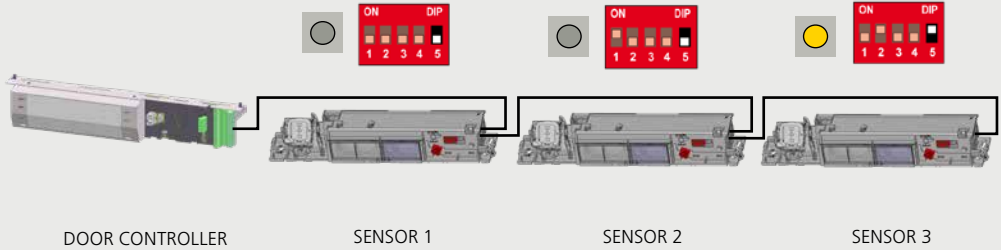

## BEA REMOTE CONTROL

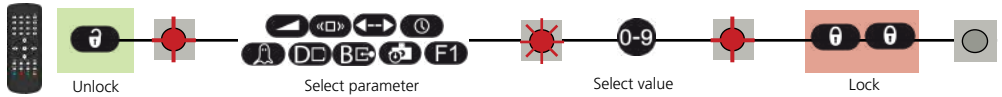

## 6 PRESETTINGS

You can choose one of the following presettings:



**STANDARD:** standard in- and outdoor installations  
factory values for immunities, IR number and redirection



**CRITICAL ENVIRONMENT:** critical installations due to surroundings or weather  
increased immunities, 1 curtain



**SHOPPING STREET:** installations in narrow streets with pedestrian traffic  
increased immunities, redirection = motion and presence



# 7 SETUP / FACTORY RESET



STEP OUT OF THE INFRARED FIELD!



## SETUP 1 (QUICK)

reference picture



## SETUP 2 (ASSISTED)

test of full door cycle + reference picture



## FACTORY RESET

complete reset to factory values



## OVERVIEW OF SETTINGS

















	0	1	2	3	4	5	6	7	8	9		
RADAR FIELD SIZE	small	>	>	>	>	>	>		>	large		
RADAR IMMUNITY	low		>	>	>	>	>	>	>	high		
RADAR DIRECTION	radar off	bi	uni	uni PRM	uni AWAY	bi shop	uni shop	PRM shop	PRM: for persons with reduced mobility AWAY: unidirectional motion away from sensor auto: automatic adaptation of field size (small shops)			
RADAR HOLDTIME	0.5 s	1 s	2 s	3 s	4 s	5 s	6 s	7 s	8 s	9 s		
IR IMMUNITY	↑ < 2.8 m		low	normal	high	higher	highest	normal	high	≥ 2.8 m : 6 + 7 (EN 16005)		
IR FREQUENCY	A	B	Sensors mounted close to each other need a different frequency.									
IR NUMBER	service mode	1	2	service mode = no IR detection during 15 minutes (maintenance). This value excludes conformity of the door system to EN 16005 and DIN 18650.								
IR PRESENCE TIME	motion	15 s	30 s	1 min	2 min	5 min	10 min	20 min	60 min	infinite min. value for DIN18650: 1 min min. value for EN16005: 30 s		
IR WIDTH		WW	NN	WW	WW	NN	NN	WN	NW	NN	NN	
REDIRECTION	motion	motion or presence	motion and presence	opening output is active in case of:						0 motion detection	1 motion or presence detection	2 motion and presence detection

factory value



excludes conformity of the door system according to EN 16005 / DIN 18650. IR Immunity on values 4 or 5 is incompatible with IR presence time on value 0  
 not allowed when the sensor is used in emergency exits

## TROUBLESHOOTING

	The ORANGE LED flashes quickly.	DIP-switch setting awaiting confirmation.	Cut and restore power to confirm the DIP-switch setting
E1 	ORANGE LED flashes 1 x.	The sensor signals an internal fault.	<b>1</b> Replace sensor.
E2 	ORANGE LED flashes 2 x.	The power supply is too low or too high.	<b>1</b> Check power supply. <b>2</b> Check wiring.
E4 	ORANGE LED flashes 4 x.	The sensor receives not enough IR-energy.	<b>1</b> Decrease the angle of the IR-curtains. <b>2</b> Increase the IR-immunity filter (values >2.8 m). <b>3</b> Deactivate 1 curtain.
E5 	ORANGE LED flashes 5 x.	The sensor receives too much IR-energy.	<b>1</b> Slightly increase the angle of the IR-curtains. Decrease the IR-immunity filter (values 1-3 <2.8 m).
E6 	ORANGE LED flashes 6 x.	Faulty radar sensor output	<b>1</b> Replace sensor.
E7 	ORANGE LED flashes 7 x.	The internal test of the radar is disturbed.	<b>1</b> Change radar field angle or antenna. <b>2</b> Launch a quick setup. <b>3</b> If orange LED flashes again, replace sensor.
E8 	ORANGE LED flashes 8 x.	IR power emitter is faulty.	<b>1</b> Replace sensor.
E9 	ORANGE LED flashes 9 x.	Internal reference of the radar is faulty.	<b>1</b> Replace sensor.
	ORANGE LED is on.	The sensor encounters a memory problem.	<b>1</b> Cut and restore power supply. <b>2</b> If orange LED lights up again, replace sensor.
	RED LED flashes quickly after an assisted setup.	The sensor sees the door during the assisted setup.	<b>1</b> Move the IR-curtains away from the door. <b>2</b> Install the sensor as close to the door as possible. If needed, use a bracket accessory. <b>3</b> Launch a new assisted setup.
	RED LED lights up sporadically.	The sensor vibrates.	<b>1</b> Check if the sensor is fastened firmly. <b>2</b> Check position of cable and cover.
		The sensor sees the door.	<b>1</b> Launch an assisted setup and adjust the IR angle.
		The sensor is disturbed by external conditions.	<b>1</b> Increase the IR-immunity filter to value 3 (< 2,8 m). <b>2</b> Select presetting 2 or 3.
	GREEN LED lights up sporadically.	The sensor is disturbed by rain and/or leaves.	<b>1</b> Select presetting 2 or 3. <b>2</b> Increase radar-immunity filter.
		Ghosting created by door movement.	<b>1</b> Change radar field angle.
		The sensor vibrates.	<b>1</b> Check if the sensor and door cover is fastened firmly. <b>2</b> Check position of cable and cover.
		The sensor sees the door or other moving objects.	<b>1</b> Remove the objects if possible. <b>2</b> Change radar field size or angle.
	The LED is off.		<b>1</b> Check power supply and wiring.
	The reaction of the door does not correspond to the LED-signal.		<b>1</b> Check CAN communication.
	The remote control does not react.	The sensor is protected by a password.	<b>1</b> Enter the right password. If you forgot the code, cut and restore the power supply to access the sensor without entering a password during 1 minute.

## TECHNICAL SPECIFICATIONS

\* The Equipment must be powered by a SELV limited power source ensuring double insulation between primary voltages and the Equipment supply. The supply current should be limited to max 3A.

Supply voltage*:	12 V - 30 V DC +/-10%
Power consumption:	< 2.5 W
Mounting height:	2 m to 3.5 m
Temperature range:	-25°C to +55°C; 0-95% relative humidity, non condensing
Degree of protection:	IP54
Noise:	< 70 dB
Expected lifetime:	20 years



Detection mode:	Motion Min. detection speed: 5 cm/s	Presence Typical response time: < 200 ms (max. 500 ms)
Technology:	Microwave doppler radar Transmitter frequency: 24.150 GHz Transmitter radiated power: < 20 dBm EIRP Transmitter power density: < 5 mW/cm <sup>2</sup>	Active infrared with background analysis Spot: 5 cm x 5 cm (typ) Number of spots: max. 24 per curtain Number of curtains: 2
Communication interface:	CAN	CAN
Safety Standards:	EN ISO 13849-1 PL «d» CAT. 2 EN 16005 (emergency exits) DIN 18650-1 (emergency exits) AutSchR	EN ISO 13849-1 PL «c» CAT. 2 (under the condition that the door control system monitors the sensor at least once per door cycle)  EN 16005 (protective devices) DIN 18650-1 (protective devices) EN 12978

PLEASE KEEP FOR FURTHER USE - DESIGNED FOR COLOUR PRINTING



Specifications are subject to changes without prior notice.  
All values measured in specific conditions and in a temperature of 25°C.

©BEA | Original instructions | 47.0162 / V6 - 02.21



BEA SA | UEGE Science Park | Allée des Noisetiers, 5 - 4031 ANGLEUR [BELGIUM] | T +32 4 361 65 65 | F +32 4 361 28 58 | info-eu@beasensors.com | www.beasensors.com



BEA hereby declares that the IXIO-D CAN is in conformity with the European directives : 2014/53/EU (RED), 2006/42/EC (Machinery) and 2011/65/EU (ROHS).

Notified Body for EC-type inspection: 0044 - TÜV NORD CERT GmbH, Langemarckstr. 20, D-45141 Essen

EC-type examination certificate number: 44 205 13089612

Angleur, february 2021 Estelle GRAAS

The complete declaration of conformity is available on our website



This product should be disposed of separately from unsorted municipal waste

A Halma company